

Keysight U3606B Multimeter|DC Power Supply

THIS PAGE HAS BEEN INTENTIONALLY LEFT BLANK.

NOTICE: This document contains references to Agilent Technologies. Agilent's former Test and Measurement business has become Keysight Technologies. For more information, go to www.keysight.com.



Notices

© Keysight Technologies 2013, 2014

No part of this manual may be reproduced in any form or by any means (including electronic storage and retrieval or translation into a foreign language) without prior agreement and written consent from Keysight Technologies as governed by United States and international copyright laws.

Manual Part Number

U3606-90054

Edition

Edition 2, August 2014

Keysight Technologies
1400 Fountaingrove Parkway
Santa Rosa, CA 95403

Warranty

The material contained in this document is provided “as is,” and is subject to change, without notice, in future editions. Further, to the maximum extent permitted by the applicable law, Keysight disclaims all warranties, either express or implied, with regard to this manual and any information contained herein, including but not limited to the implied warranties of merchantability and fitness for a particular purpose. Keysight shall not be liable for errors or for incidental or consequential damages in connection with the furnishing, use, or performance of this document or of any information contained herein. Should Keysight and the user have a separate written agreement with warranty terms covering the material in this document that conflict with these terms, the warranty terms in the separate agreement shall control.

Technology Licenses

The hardware and or software described in this document are furnished under a license and may be used or copied only in accordance with the terms of such license.

Restricted Rights Legend

U.S. Government Restricted Rights. Software and technical data rights granted to the federal government include only those rights customarily provided to end user customers. Keysight provides this customary commercial license in Software and technical data pursuant to FAR 12.211 (Technical Data) and 12.212 (Computer Software) and, for the Department of Defense, DFARS 252.227-7015 (Technical Data - Commercial Items) and DFARS 227.7202-3 (Rights in Commercial Computer Software or Computer Software Documentation).

Safety Notices

CAUTION











A **CAUTION** notice denotes a hazard. It calls attention to an operating procedure, practice, or the likes of that, if not correctly performed or adhered to, could result in damage to the product or loss of important data. Do not proceed beyond a **CAUTION** notice until the indicated conditions are fully understood and met.

WARNING

A **WARNING** notice denotes a hazard. It calls attention to an operating procedure, practice, or the likes of that, if not correctly performed or adhered to, could result in personal injury or death. Do not proceed beyond a **WARNING** notice until the indicated conditions are fully understood and met.

Safety Symbols

The following symbols on the instrument and in the documentation indicate precautions which must be taken to maintain safe operation of the instrument.

	Direct current (DC)		Off (supply)
	Alternating current (AC)		On (supply)
	Both direct and alternating current		Caution, risk of danger (refer to this manual for specific Warning or Caution information)
	Earth (ground) terminal		Out position of a bi-stable push control
	Frame or chassis terminal		In position of a bi-stable push control
CAT II 300 V	Category II 300 V over-voltage protection		

Safety Considerations

Read the information below before using this instrument.

The following general safety precautions must be observed during all phases of operation, service, and repair of this instrument. Failure to comply with these precautions or with specific warnings elsewhere in this manual violates safety standards for design, manufacture, and intended use of the instrument. Keysight Technologies assumes no liability for the customer's failure to comply with these requirements.

WARNING

- **Do not use the device if it is damaged. Before you use the device, inspect the casing. Look for cracks or missing plastic. Do not operate the device around explosive gas, vapor, or dust.**
 - **Always use the device with the cables provided.**
 - **Observe all markings on the device before establishing any connection.**
 - **Turn off the device and application system power before connecting to the I/O terminals.**
 - **When servicing the device, use only the specified replacement parts.**
 - **Do not operate the device with the cover removed or loosened.**
 - **Use only the power adapter provided by the manufacturer to avoid any unexpected hazards.**
-

CAUTION

- If the device is used in a manner not specified by the manufacturer, the device protection may be impaired.
 - Always use dry cloth to clean the device. Do not use ethyl alcohol or any other volatile liquid to clean the device.
 - Do not permit any blockage of the ventilation holes of the device.
-

Environmental Conditions

This instrument is designed for indoor use and in an area with low condensation. The table below shows the general environmental requirements for this instrument.

Table 1

Environmental condition	Requirement
Temperature	<ul style="list-style-type: none">• Operating condition<ul style="list-style-type: none">• 0 °C to 55 °C• Storage condition<ul style="list-style-type: none">• -40 °C to 70 °C
Humidity	<ul style="list-style-type: none">• Operating condition<ul style="list-style-type: none">• Up to 80% RH at 40°C (non-condensing)• Storage condition<ul style="list-style-type: none">• Up to 95% RH at 40°C (non-condensing)
Altitude	Up to 2000 m
Pollution degree	2

NOTE

The U3606B complies with the following safety and EMC compliances:





Safety compliance

- IEC 61010-1:2001/EN 61010-1:2001 (2nd Edition)
- Canada: CAN/CSA-C22.2 No. 61010-1-04
- USA: ANSI/UL 61010-1:2004

EMC compliance

- IEC 61326-1:2005/EN61326-1:2006
- CISPR11:2003/EN55011:2007, Group 1 Class A
- Canada: ICES/NMB-001:Issue 4, June 2006
- Australia/New Zealand: AS/NZS CISPR 11:2004

Regulatory Markings

 <p>ISM 1-A</p>	<p>The CE mark is a registered trademark of the European Community. This CE mark shows that the product complies with all the relevant European Legal Directives.</p>	 <p>N10149</p>	<p>The C-tick mark is a registered trademark of the Spectrum Management Agency of Australia. This signifies compliance with the Australia EMC Framework regulations under the terms of the Radio Communication Act of 1992.</p>
<p>ICES/NMB-001</p>	<p>ICES/NMB-001 indicates that this ISM device complies with the Canadian ICES-001. Cet appareil ISM est conforme a la norme NMB-001 du Canada.</p>		<p>This instrument complies with the WEEE Directive (2002/96/EC) marking requirement. This affixed product label indicates that you must not discard this electrical or electronic product in domestic household waste.</p>
 <p>C US</p>	<p>The CSA mark is a registered trademark of the Canadian Standards Association.</p>		<p>This symbol indicates the time period during which no hazardous or toxic substance elements are expected to leak or deteriorate during normal use. Forty years is the expected useful life of the product.</p>

Waste Electrical and Electronic Equipment (WEEE) Directive 2002/96/EC

This instrument complies with the WEEE Directive (2002/96/EC) marking requirement. This affixed product label indicates that you must not discard this electrical or electronic product in domestic household waste.

Product Category:

With reference to the equipment types in the WEEE directive Annex 1, this instrument is classified as a “Monitoring and Control Instrument” product.

The affixed product label is as shown below.



Do not dispose in domestic household waste.

To return this unwanted instrument, contact your nearest Keysight Service Center, or visit

www.keysight.com/environment/product

for more information.

Declaration of Conformity (DoC)

The Declaration of Conformity (DoC) for this instrument is available on the Keysight website. You can search the DoC by its product model or description at the web address below.

<http://regulations.products.keysight.com/DoC/search.htm>

NOTE

If you are unable to search for the respective DoC, please contact your local Keysight representative.

Table of Contents

1 Introduction

About This Manual	2
Documentation map	2
Safety notes	2
Preparing the U3606B	3
Check the shipment	3
Connect power to the instrument	5
Adjust the carry handle	7
Rack mount the instrument	8
Stack multiple U3606B units	10
The U3606B in Brief	11
Dimensions	11
Overview	12
Display screen	15
Keypad	18
Input/Output terminals	24

2 Operation and Features

Measuring Voltage	30
Measuring Current	33
Measuring Resistance	36
Testing Continuity	39
Measuring Low-Resistance	42
Measuring Capacitance	47
Testing Diodes	50
Measuring Frequency/Pulse Width/Duty Cycle (Voltage Path)	53

Measuring Frequency/Pulse Width/Duty Cycle (Current Path)	56
Selecting a Range	59
Setting the Resolution	61
Math Operations	62
Null	63
dBm measurements	66
dB measurements	67
MinMax	69
Limit	70
Hold	73
Triggering the Multimeter	75
Front panel triggering	76
Remote interface triggering	77

3 DC Power Supply Operation

Constant Voltage Operation	80
Constant Current Operation	83
Protection Functions	86
Over-voltage protection (OVP)	86
Over-current protection (OCP)	90
Over-voltage limit (OV)	94
Over-current limit (OC)	97
Square-Wave Operation	100
Sweep Functions	106
Ramp signal	106
Scan signal	109
Selecting a Range	113
Enabling the Output	114
Remote Sensing	115

4 System-Related Operation

Using the Utility Menu	124
Utility Menu Summary	126
Utility Menu Items	129
Reading error messages	129
Configuring the data logging parameters	130
Recording measurement data (data logging)	131
Enabling refresh hold	132
Setting the smooth function	133
Configuring the scan signal parameters	136
Configuring the ramp signal parameters	138
Setting the output protection state	140
Adjusting the soft start output	141
Selecting a dBm reference resistance value	142
Performing a self-test	142
Connecting to a remote interface	143
Configuring the beeper	144
Changing the power-on state	145
Adjusting the display brightness	146
Reading the program code revision	146
Storing and Recalling Instrument States	147
Storing a state	148
Recalling a stored state	149
Remote Operation	150
Configuring and connecting the GPIB interface	151
Configuring and connecting the USB interface	152
SCPI commands	152

5 Characteristics and Specifications

Product Characteristics	156
-------------------------	-----

Digital Multimeter Specifications	158
Specification assumptions	158
DC specifications	159
AC specifications	163
Frequency specifications	165
Duty cycle and pulse width specifications	167
Operating specifications	167
Supplemental characteristics	169
DC Power Supply Specifications	173
Safety considerations	173
Specifications assumptions	173
Performance specifications	174
Supplemental characteristics	176

6 List of Error Messages

Error Messages	182
Command errors	183
Execution errors	184
Internal errors	185
Query errors	185
Device specific errors	185
Self-test errors	186
Calibration errors	187

List of Figures

Figure 1-1	Single rack mounted U3606B	8
Figure 1-2	Two U3606B rack mounted side-by-side	8
Figure 1-3	Rack mount dimensions	9
Figure 1-4	U3606B dimensions	11
Figure 1-5	The front panel at a glance	12
Figure 1-6	The rear panel at a glance	13
Figure 1-7	The VFD display at a glance	15
Figure 1-8	The keypad at a glance	18
Figure 1-9	The input/output terminals at a glance	24
Figure 3-1	Remote sensing connections	116
Figure 3-2	Local sensing connections	116

THIS PAGE HAS BEEN INTENTIONALLY LEFT BLANK.

List of Tables

Table 1-1	Front panel descriptions	12
Table 1-2	Rear panel descriptions	14
Table 1-3	VFD display descriptions	15
Table 1-4	Keypad descriptions	19
Table 1-5	Input terminal connections	25
Table 1-6	Output terminal connections	26
Table 2-1	Voltage measurement summary	31
Table 2-2	Current measurement summary	34
Table 2-3	Resistance measurement summary	38
Table 2-4	Continuity test summary	41
Table 2-5	Low-resistance measurement summary	44
Table 2-6	Low-resistance test current values	45
Table 2-7	Capacitance measurement summary	49
Table 2-8	Diode test summary	52
Table 2-9	Frequency/pulse width/duty cycle measurement (voltage path) summary	55
Table 2-10	Frequency /pulse width/duty cycle measurement (current path) summary	58
Table 2-11	Math operations summary	62
Table 3-1	CC mode over-voltage protection range and values	88
Table 3-2	CV mode over-current protection range and values	92
Table 3-3	CC mode over-voltage range and values	96
Table 3-4	CV mode over-current range and values	99
Table 3-5	Square-wave amplitude minimum and maximum values	105
Table 3-6	Available ranges for DC power supply functions	113
Table 4-1	Utility menu summary	126
Table 4-2	Scan signal parameters	136
Table 4-3	Ramp signal parameters	138
Table 4-4	System protection values	140
Table 5-1	DC accuracy specifications \pm (% of reading + % of range)	159
Table 5-2	AC accuracy specifications \pm (% of reading + % of range)	163
Table 5-3	Frequency accuracy specifications \pm (% of reading + %	

	of range)	165
Table 5-4	Frequency sensitivity for voltage measurement	166
Table 5-5	Frequency sensitivity for current measurement	166
Table 5-6	Duty cycle and pulse width resolution and accuracy	167
Table 5-7	Reading speed (typical)	167
Table 5-8	DC power supply performance specifications	174
Table 5-9	DC power supply supplemental characteristics	176
Table 5-10	Square-wave output characteristics	177
Table 5-11	Scan output characteristics	179
Table 5-12	Ramp output characteristics	179
Table 6-1	List of command errors	183
Table 6-2	List of execution errors	184
Table 6-3	List of internal errors	185
Table 6-4	List of query errors	185
Table 6-5	List of device specific errors	185
Table 6-6	List of self-test errors	186
Table 6-7	List of calibration errors	187

1

Introduction

About This Manual	2
Documentation map	2
Safety notes	2
Preparing the U3606B	3
Check the shipment	3
Connect power to the instrument	5
Adjust the carry handle	7
Rack mount the instrument	8
Stack multiple U3606B units	10
The U3606B in Brief	11
Dimensions	11
Overview	12
Display screen	15
Keypad	18
Input/Output terminals	24

This chapter teaches you how to set up the U3606B for the first time. A summary of all the features of the U3606B is also given.

About This Manual

The descriptions and instructions in this manual apply to the Keysight U3606B Multimeter|DC Power Supply (hereafter referred to as the *U3606B* or the *instrument*).

Documentation map

The following manuals are available for your instrument. For the latest version, please visit our website at:

<http://www.keysight.com/find/U3606B>.

Check the manual revision on the first page of each manual.

- **User's Guide.** This manual.
- **Quick Start Guide.** Printed copy, included with the shipment.
- **Programmer's Reference.** Free download at the Keysight website.

Safety notes

Safety notes are used throughout this manual (see the "Safety Notices" section for format examples). Familiarize yourself with each of the notes and its meaning before operating your instrument.

More pertinent safety notes for using this product are located under the "Safety Considerations" section.

Do not proceed beyond a safety notice until the indicated conditions are fully understood and met.

Preparing the U3606B

Check the shipment

When you receive your instrument, check the shipment according to the following procedure.

- 1 Inspect the shipping container for damage. Signs of damage may include a dented or torn shipping container or cushioning material that indicates signs of unusual stress or compacting. Save the packaging material in case the instrument needs to be returned.
- 2 Carefully remove the contents from the shipping container, and verify that the standard accessories and your ordered options are included in the shipment according to the standard shipped items list shown below.
- 3 For any question or problems, refer to the Keysight contact numbers on the back of this manual.

Standard shipped items

Verify that you have received the following items in the shipment of the U3606B. If anything is found missing or damaged, please contact your nearest Keysight Sales Office.

Keep the original packaging in case the U3606B has to be returned to Keysight in the future. If you return the U3606B for service, attach a tag identifying the owner and model number. Also, include a brief description of the problem.

1 Introduction
Preparing the U3606B

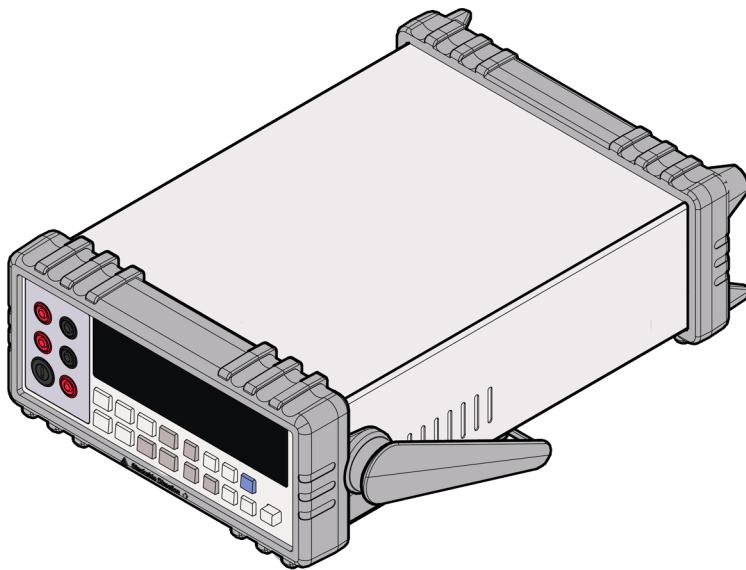

Keysight U3606B Multimeter | DC Power Supply

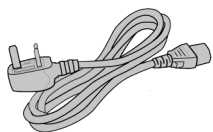

Power cord



U8201A combo test lead kit



USB Standard-A to Type-B interface cable

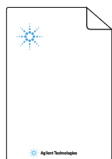

Certificate of Calibration



Keysight U3606B Quick Start Guide

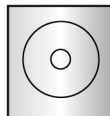

Keysight Automation-Ready CD-ROM

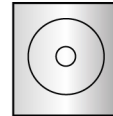

Keysight U3606B Product Reference CD-ROM

Connect power to the instrument

NOTE

The U3606B is shipped from the factory with a power-line cord that has a plug appropriate for your location. The U3606B is equipped with a three-wire grounding type power cord; the third conductor being the ground.

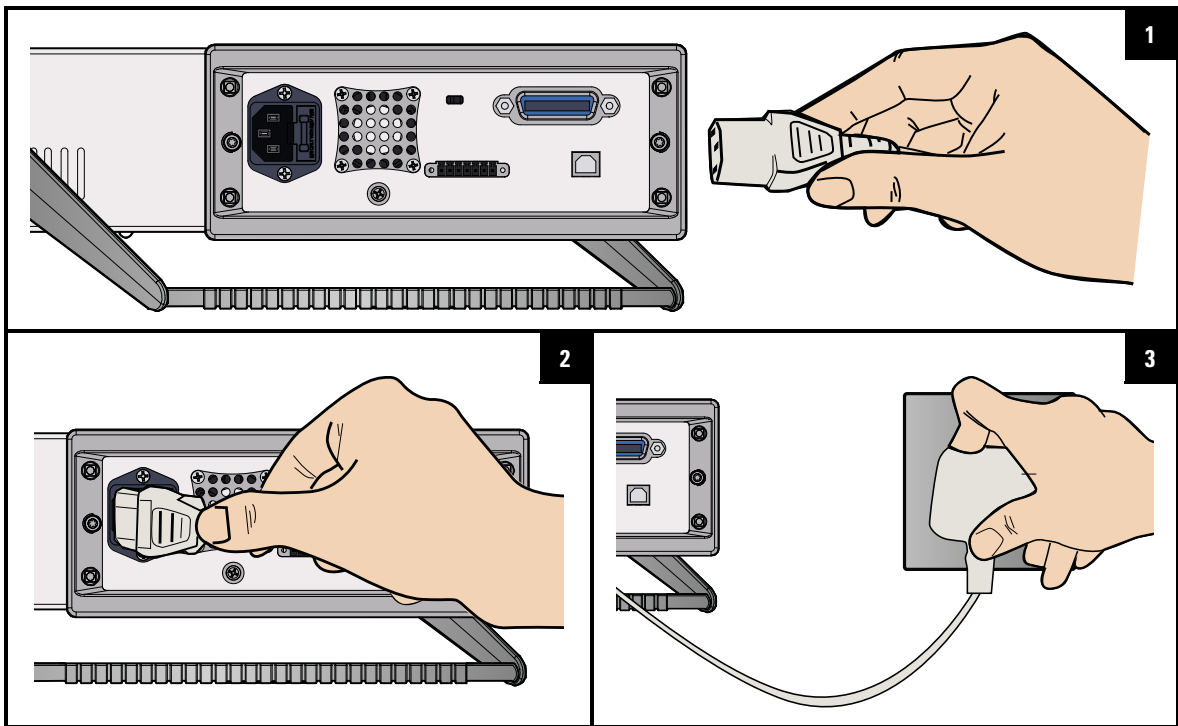

WARNING

The mains plug should only be inserted into a socket outlet that provides protective earth contact.

CAUTION

The U3606B is grounded only when the power-line cord is plugged into an appropriate receptacle. Do not operate your instrument without adequate ground connection.

1 Introduction

Preparing the U3606B

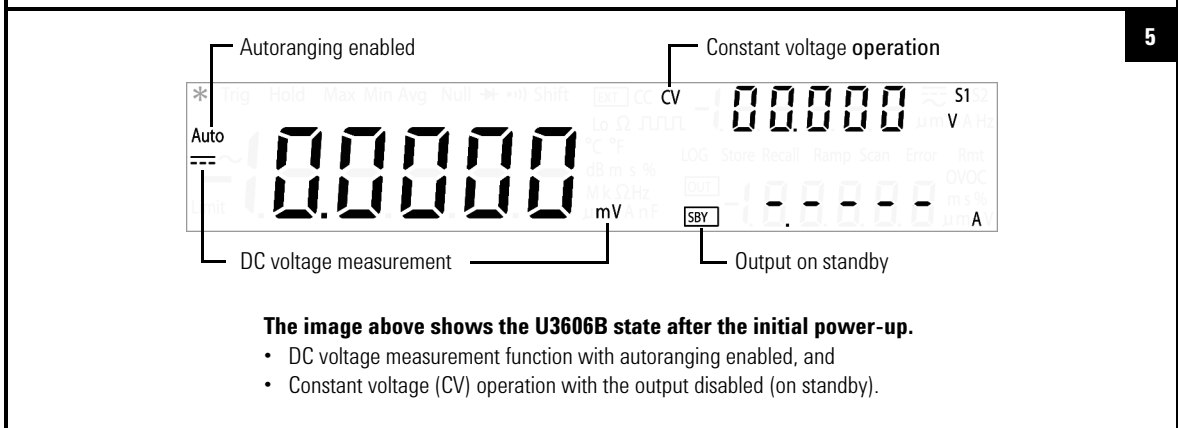
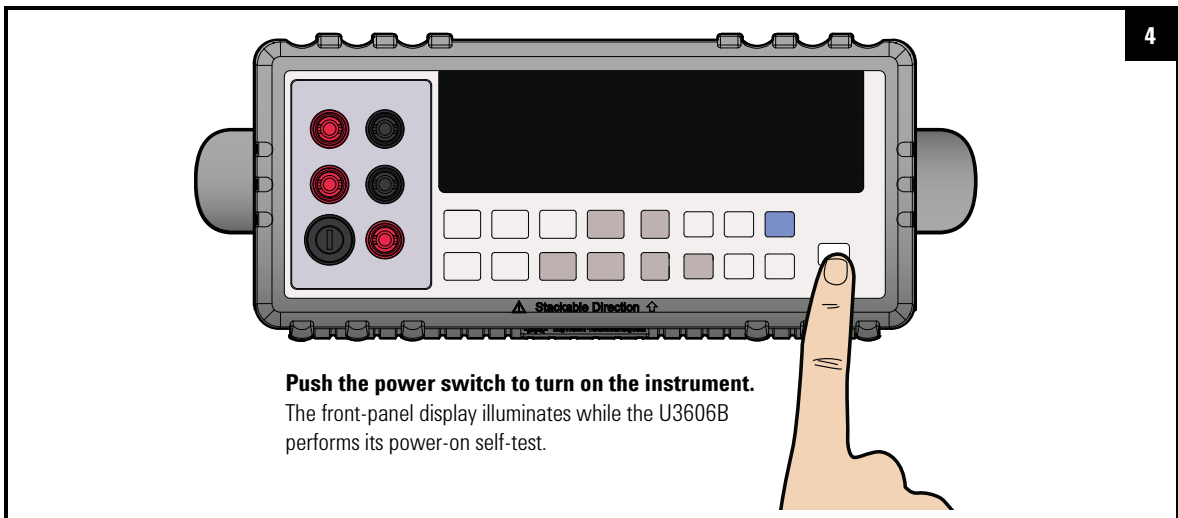

NOTE

- For subsequent power cycles, the U3606B returns to the last power-off state by default. You can change this behavior in the Utility menu.
- If the self-test is unsuccessful, **Error** is displayed on the right side of the display. Press **[Shift] > [Utility]** to read the error number in the Utility menu.
- A more extensive self-test is also available from the Utility menu.

Adjust the carry handle

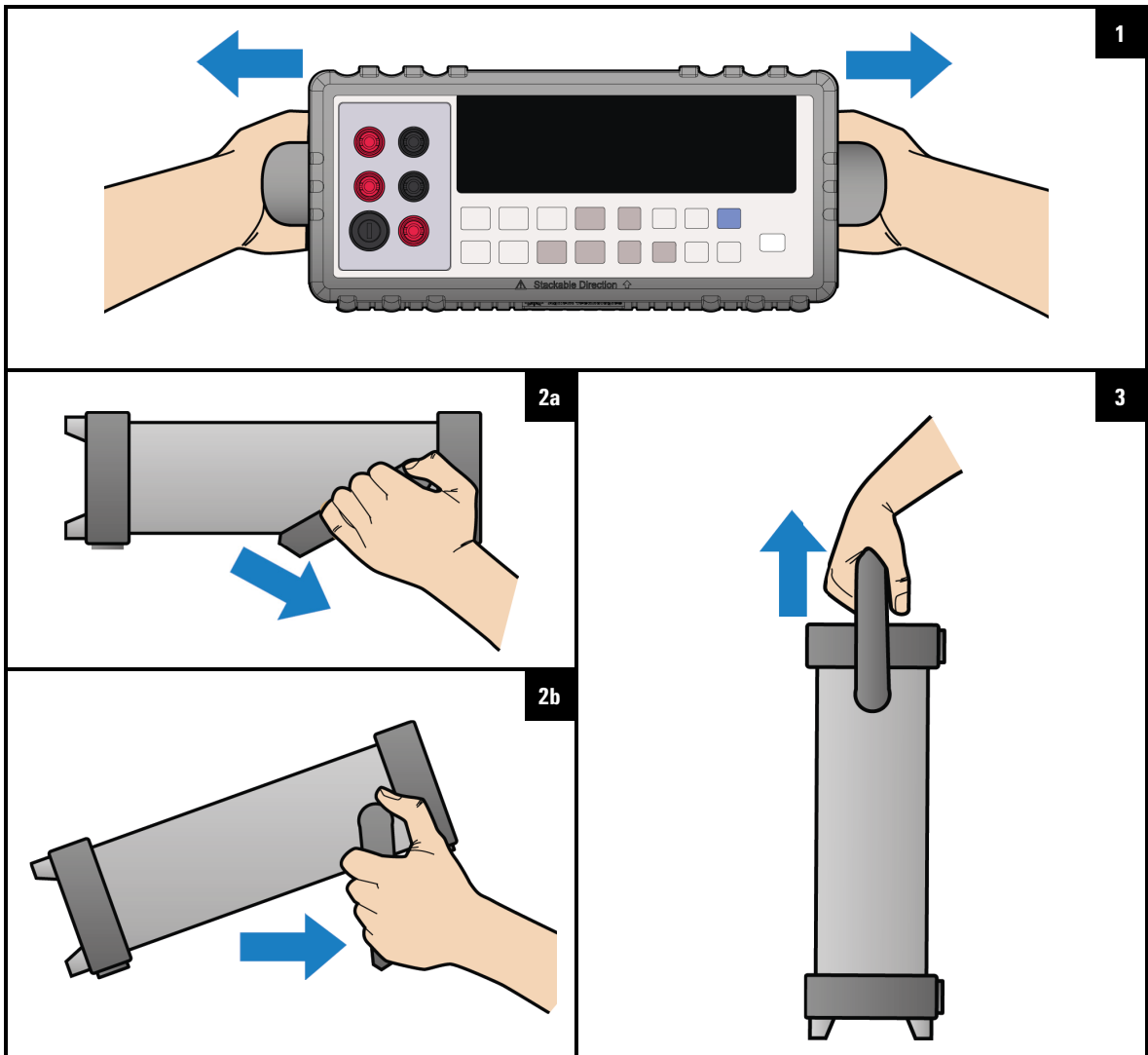

Rack mount the instrument

You can mount the U3606B in a standard 19-inch rack cabinet using one of the two optional kits available. Instructions and mounting hardware are included with each rack-mounting kit.

To rack mount a single instrument, order 34190A.

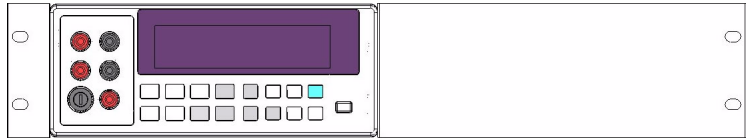

Figure 1-1 Single rack mounted U3606B

To rack mount two instruments side-by-side, order 1CM011A. Be sure to use the support rails inside the rack cabinet. This configuration only works for two U3606B mounted side-by-side.

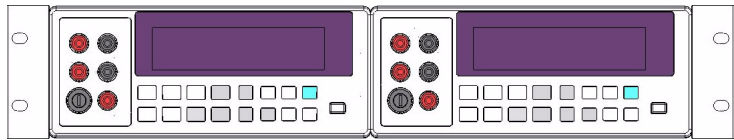

Figure 1-2 Two U3606B rack mounted side-by-side

Remove the carrying handle and the front and rear rubber bumpers before rack-mounting the instrument.

- 1** To remove the handle, rotate it to a vertical position and pull the ends outward.
- 2** To remove the rubber bumpers, stretch a corner and slide it off.

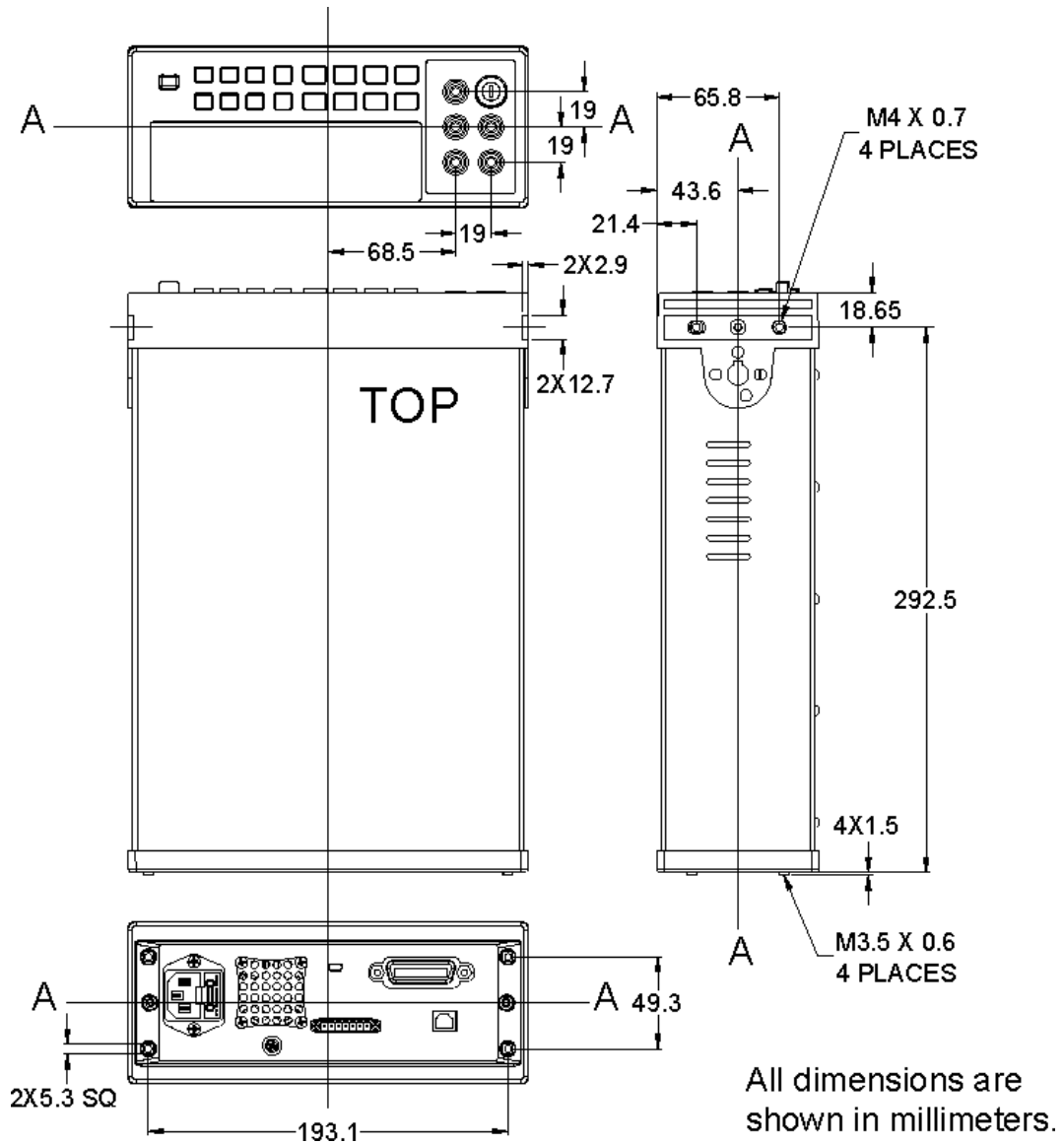

Figure 1-3 Rack mount dimensions

1 Introduction

Preparing the U3606B

Stack multiple U3606B units

You may stack multiple U3606B units on top of each other.

The rubber bumpers are uniquely designed to secure firmly the units stacked above it, preventing any unwanted movements.

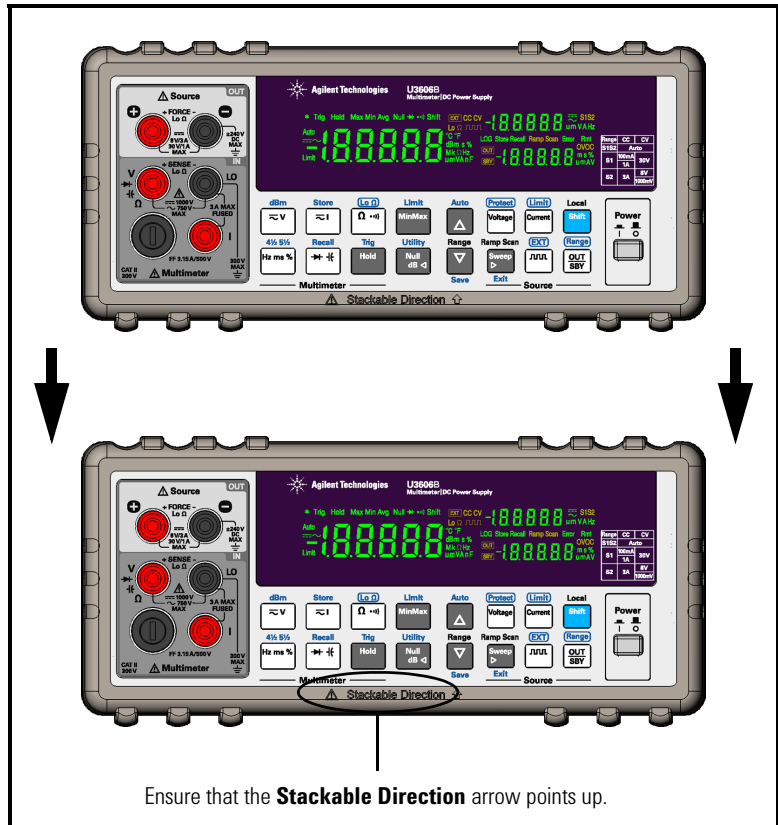

The U3606B in Brief

Dimensions

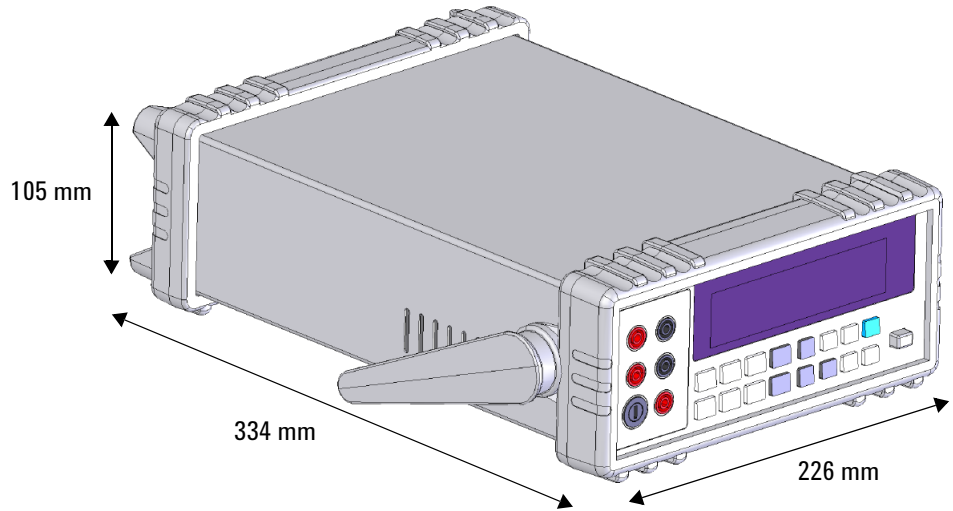

Figure 1-4 U3606B dimensions

1 Introduction
The U3606B in Brief

Overview

Front panel

The front panel parts of the U3606B are described in this section.

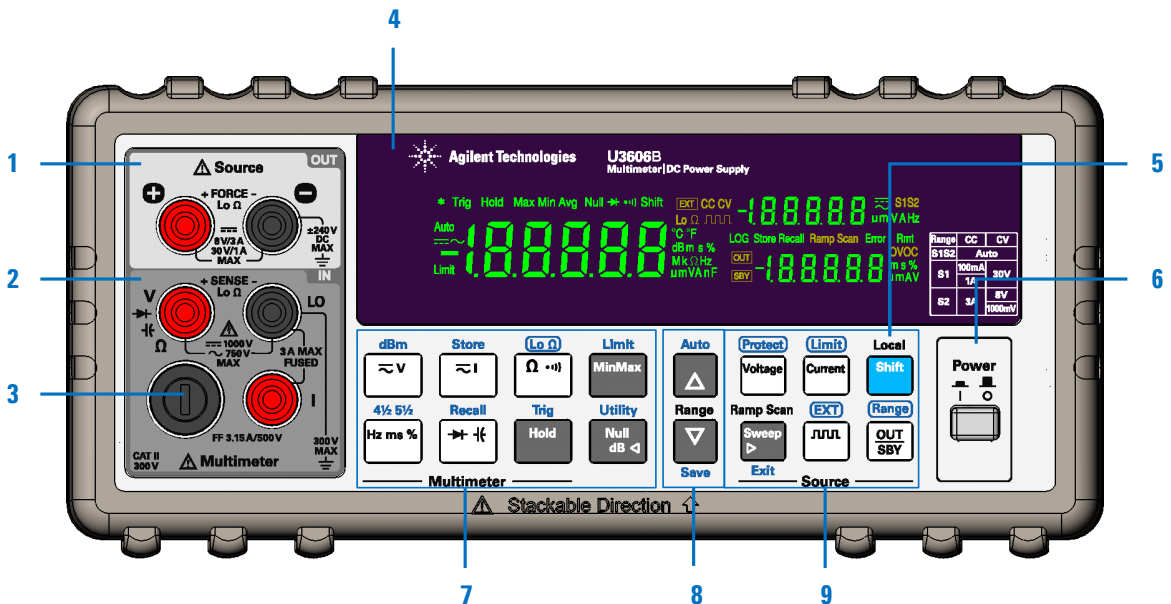

Figure 1-5 The front panel at a glance

Table 1-1 Front panel descriptions

Legend	Description
1 Output terminals	Positive and negative terminals for <i>output</i> connections
2 Input terminals	Positive terminals and negative terminal (shared) for <i>input</i> connections
3 Current fuse	3.15 A/500 V F/B 6.3 × 32 mm fuse
4 VFD display	Displays the instrument settings and readings
5 [Shift]/[Local]	Selects Shift functions and enables front panel operation during remote lock

Table 1-1 Front panel descriptions (continued)

Legend	Description
6 [Power]	Turns the instrument on or off
7 Keys for multimeter operation	Function keys for multimeter operation
8 Autorange and manual range	Selects a manual range or enables autoranging for multimeter operation
9 Keys for source operation	Function keys for source operation

Rear panel

The rear panel parts of the U3606B are described in this section.

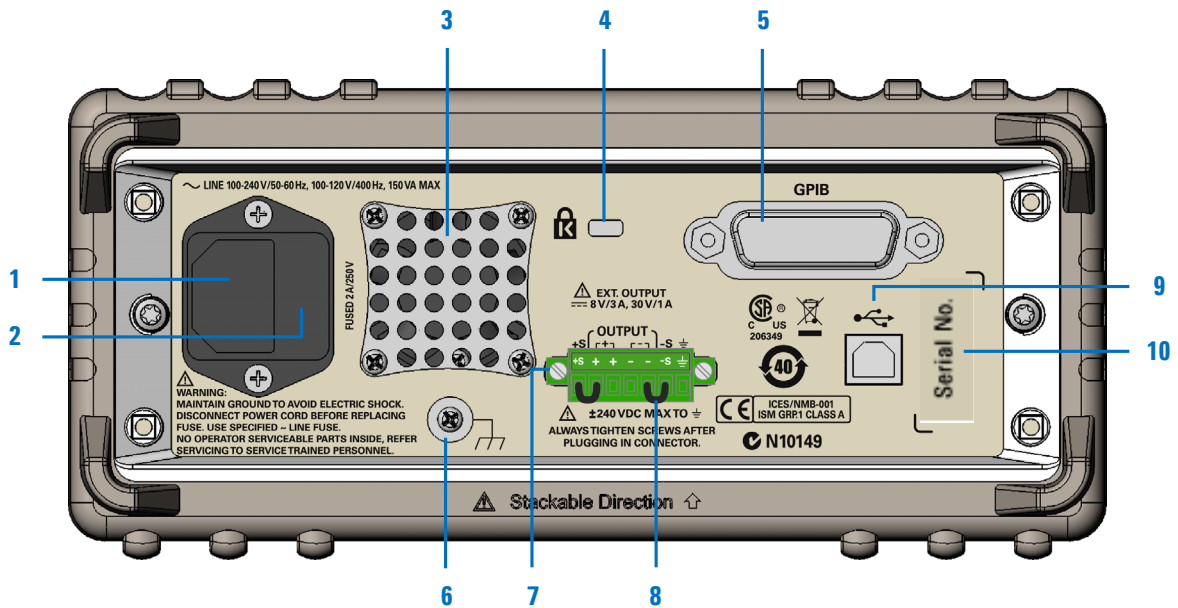

Figure 1-6 The rear panel at a glance

1 Introduction

The U3606B in Brief

Table 1-2 Rear panel descriptions

Legend	Description
1 AC inlet	Connects the AC power line — plug the power cord firmly in here
2 AC line fuse	To maintain protection, replace this fuse only with a fuse of the specified type and rating
3 Ventilation fan	Ventilation fan to exhaust heat and air from the instrument
4 Kensington security slot	Anti-theft system using Kensington locks
5 GPIB interface connector	GPIB (IEEE-488) connector physical interface
6 Chassis ground lug	Connect to earth ground or to unit chassis to eliminate noise caused by ground loops
7 Rear output terminals	Positive and negative terminals for remote sense
8 Short bars	Shorts the rear output (+ and –) and sense (+S and –S) terminals
9 USB interface connector	Type-B USB connector physical interface
10 Serial number	Indicated the instrument's serial number

Display screen

The display annunciators of the U3606B are described in this section.

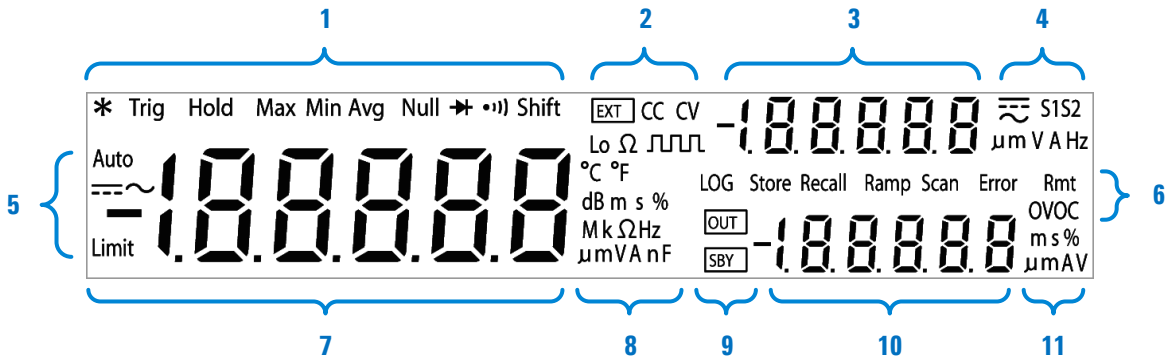

Figure 1-7 The VFD display at a glance

Table 1-3 VFD display descriptions

Legend	Description
*	A single reading is taken from the <i>input</i> terminals
Trig	Single trigger operation is active
Hold	Hold math operation enabled
MinMaxAvg	MinMax math operation enabled
1 Avg	When Avg is flashing, the smooth function is enabled
Null	Null math operation enabled
→ •)	Diode test function selected
•)	Continuity test function selected
Shift	Shift mode selected

1 Introduction
The U3606B in Brief

Table 1-3 VFD display descriptions (continued)







	Legend	Description
	EXT	Remote sensing operation enabled
	CC	Constant current operation selected
2	CV	Constant voltage operation selected
	Lo Ω	Low-resistance (4-wire) measurement selected
		Square-wave output selected
3	-1.8.8.8.8.8	Secondary display for source operation
	S1	Output range S1 selected — 30 V/1 A or 30 V/100 mA
	S2	Output range S2 selected — 8 V/3 A or 1000 mV/3 A
	S1S2	Autoranging enabled for constant voltage, constant current, and square-wave output operations
4	V	Voltage unit: V for constant voltage operation
	A	Current unit: A for constant current operation
	Hz	Frequency unit: Hz for square-wave output
		DC symbol
		AC symbol
	Limit	Limit math operation enabled
	Auto	Autoranging selected
5		DC measurement selected
		AC measurement selected
		AC+DC measurement selected

Table 1-3 VFD display descriptions (continued)

Legend	Description
LOG	Data logging in progress
Store	Store instrument state selected
Recall	Recall instrument state selected
Ramp	Ramp signal output selected
6 Scan	Scan signal output selected
Error	One or more errors available in the error queue
Rmt	Remote interface control is active
OV	Over-voltage condition active
OC	Over-current condition active
7 -1.8.8.8.8.8	Primary display for multimeter operation
°C	Celsius temperature unit
°F	Fahrenheit temperature unit
dB	Decibel unit relative to 1 dBm
dBm	Decibel unit relative to 1 mW
ms	Pulse width unit
8 %	Duty cycle unit
MkΩ	Resistance units: Ω, kΩ, MΩ
MkHz	Frequency units: Hz, kHz, MHz
mV	Voltage units: mV, V
mA	Current units: mA, A
μnF	Capacitance units: nF, μF
9 OUT	Output is enabled from the <i>output</i> terminals and remote sense (rear output) terminals
SBY	Output is on standby (disabled)
10 -1.8.8.8.8.8	Secondary display for source operation

1 Introduction
The U3606B in Brief

Table 1-3 VFD display descriptions (continued)

Legend	Description
ms	Pulse width unit for square-wave output
%	Duty cycle unit for square-wave output
V	Voltage unit: V for over-voltage protection
A	Current unit: A for over-current protection

Keypad

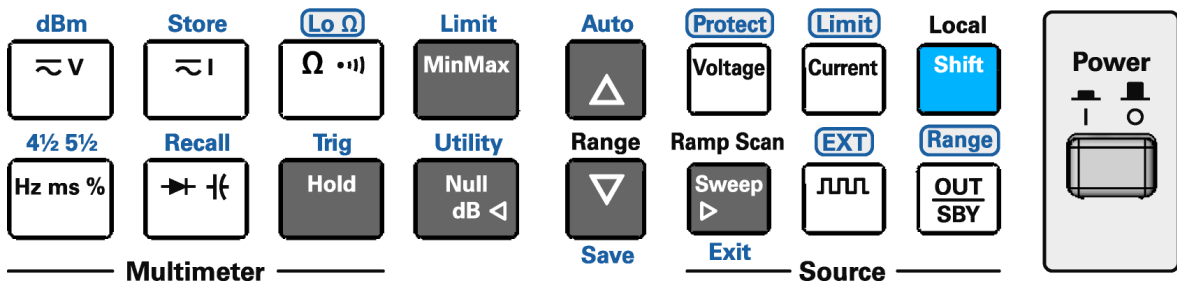

Figure 1-8 The keypad at a glance

NOTE

Pressing a key changes the current operation, illuminates a related annunciator on the display, and generates a key-click sound (a beep).

Using the Shift key

To select a **Shift** function: first, press [**Shift**] (the Shift annunciator will illuminate). Then, press the key that has the desired label above it.

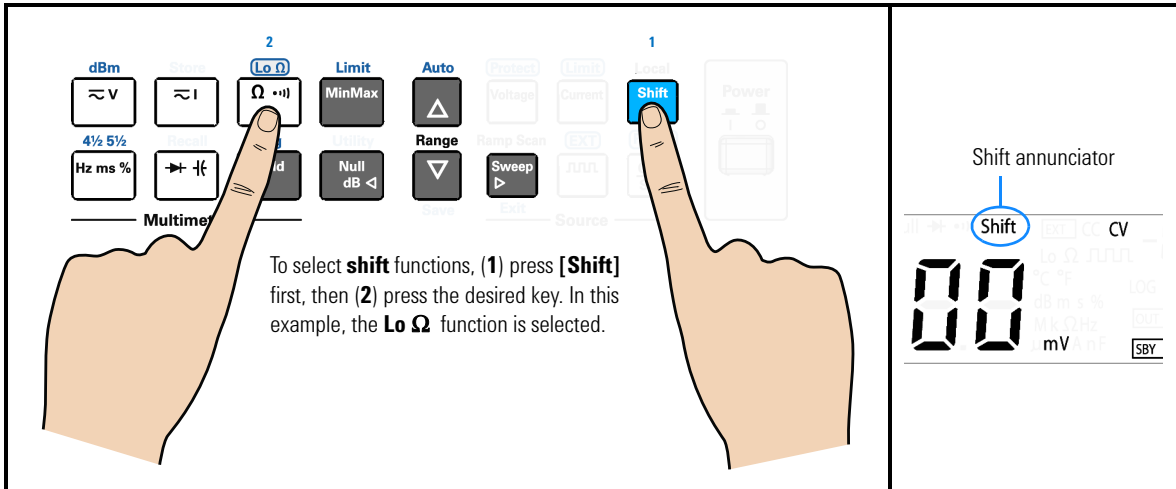

NOTE

- If you accidentally press [**Shift**], but do not want to perform a **Shift** function, just press [**Shift**] again to turn off the Shift annunciator.
- If no key-press is detected 3 seconds after [**Shift**] is pressed, the instrument will return to normal operation (the Shift annunciator turns off).

Table 1-4 Keypad descriptions

Legend	Description
System-related operation	
	Push [Power] to turn on or turn off the U3606B.

1 Introduction

The U3606B in Brief

Table 1-4 Keypad descriptions (continued)

























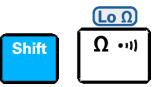

Legend	Description
Local 	<ul style="list-style-type: none"> Press [Shift] to select a shift function. Press [Local] to unlock the front-panel keys when in remote operation lock.
 	Press [Shift] > [Utility] to access the Utility menu.
 	<ul style="list-style-type: none"> Press [◀] or [▶] to step through items in the Utility menu. Press [◀] or [▶] to move the cursor to the left or to the right.
 	<ul style="list-style-type: none"> Press [▲] or [▼] to enter the edit mode in the Utility menu for configurable settings. Press [▲] or [▼] to switch between two values, to select a value from the list, or to decrease or increase a value.
 	Press [Shift] > [Save] to save the changes made in the edit mode.
 	<ul style="list-style-type: none"> Press [Shift] > [Exit] to exit the edit mode or Utility menu without saving. Press [Shift] > [Exit] to toggle off a math operation (Null, dBm, dB, MinMax, Limit, Hold).
 	Press [Shift] > [Store] to store an instrument state.
 	Press [Shift] > [Recall] to recall a previously stored instrument state.
Multimeter operation	
	Press [~V] to cycle between the DC, AC, and AC+DC voltage measurement functions.
	Press [~I] to cycle between the DC, AC, and AC+DC current measurement functions.

Table 1-4 Keypad descriptions (continued)

Legend	Description
	<ul style="list-style-type: none"> • Press [Ω \leftrightarrow] to select the resistance (2-wire) measurement function. • Press [Ω \leftrightarrow] again to select the continuity test function.
	Press [Shift] > [Lo Ω] to select the low-resistance (4-wire) measurement function.
	Press [Hz ms %] to cycle between the frequency (Hz), pulse width (ms), and duty cycle (%) measurement functions related to the voltage or current path. ^[1] The AC voltage or AC current measurement display will flash briefly before the frequency measurement display is shown.
	<ul style="list-style-type: none"> • Press [\rightarrow ∇] to select the diode test function. • Press [\rightarrow ∇] again to select the capacitance function.
	Press [Null] to enable the null math operation.
	Press [Shift] > [dBm] to convert the measured voltage value to dBm.
	Press [Shift] > [dBm] > [dB] to convert the measured voltage value to dB.
	Press [MinMax] to store statistical data for the present readings.
	Press [Shift] > [Limit] to enable the limit math operation.
	Press [Hold] to capture and hold a reading within the specified variation and threshold values. ^[2]

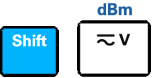
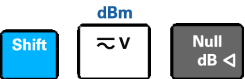
1 Introduction

The U3606B in Brief

Table 1-4 Keypad descriptions (continued)



































Legend	Description
 Range 	<ul style="list-style-type: none"> Press [] to select a higher range and disable autoranging. Press [] to select a lower range and disable autoranging.
 	Press [Shift] > [Auto] to enable autoranging and disable manual ranging.
 	Press [Shift] > [4 1/2 5 1/2] to toggle between 4 1/2 digit and 5 1/2 digit mode. ^[3]
 	Press [Shift] > [Trig] to enable the single trigger operation.
Source operation	
	Press [Voltage] to select CV output. Use the arrow keys to select a suitable voltage value.
	Press [Current] to select CC output. Use the arrow keys to select a suitable current value.
	<ul style="list-style-type: none"> Press [] to select the square-wave output. Use the arrow keys to set the voltage amplitude. Press [] again to cycle through the duty cycle, pulse width, and voltage amplitude settings.
 	When the  annunciator is flashing, press [] or [] to step through the available frequencies.
 	While the  annunciator is flashing, press [] or [] to set the voltage amplitude, or to step through the available duty cycle values or pulse width values.
Ramp Scan 	Press [Sweep] to cycle through the ramp and scan sweep functions, or to disable the sweep operation for the selected output (CV or CC). ^[4]

Table 1-4 Keypad descriptions (continued)

Legend	Description
 	Press [Shift] > [Limit] to set the over-current limit value for the CV output or the over-voltage limit value for the CC output.
 	Press [Shift] > [Protect] to set the over-current protection value for the CV output or the over-voltage protection value for the CC output ^[5] .
 	<ul style="list-style-type: none"> • CV operation: Press [Shift] > [Range] to toggle between range S1 (30 V/1 A), range S2 (8 V/3 A), range S2m (1000 mV/3 A), or S1S2 (autoranging)^[6]. • CC operation: Press [Shift] > [Range] to toggle between range S1 (30 V/1 A), range S1m (30 V/100 mA), range S2 (8 V/3 A), or S1S2 (autoranging)^[6].
	Press [OUT / SBY] to toggle between source output (OUT) and source standby (SBY).
 	Press [Shift] > [EXT] to enable remote sensing.

[1] The voltage path is the default path when you select the frequency measurement function. To switch to the current path for frequency, pulse width, and duty cycle measurements, first press [**AC I**], then press [**Hz ms %**].

[2] The refresh hold variation and threshold values can be configured through the Utility menu.

[3] The continuity and diode test functions have a fixed 4½ digit resolution. Capacitance measurement is fixed to 3½ digit resolution.

[4] The sweep functions can only be accessed when the U3606B is in constant voltage or constant current operation. You cannot access the sweep functions while the U3606B is in square-wave output operation.

[5] The over-current and over-voltage protection features are only active when the output protection state is enabled.

[6] You can only change the range when the instrument output is in the “standby” state (the SBY annunciator is illuminated).

Input/Output terminals

WARNING

Before attempting to connect test leads to the front output terminals, make sure to disable the U3606B output first to avoid damage to the circuits being connected.

CAUTION

To avoid damaging this device, do not exceed the rated input limit.

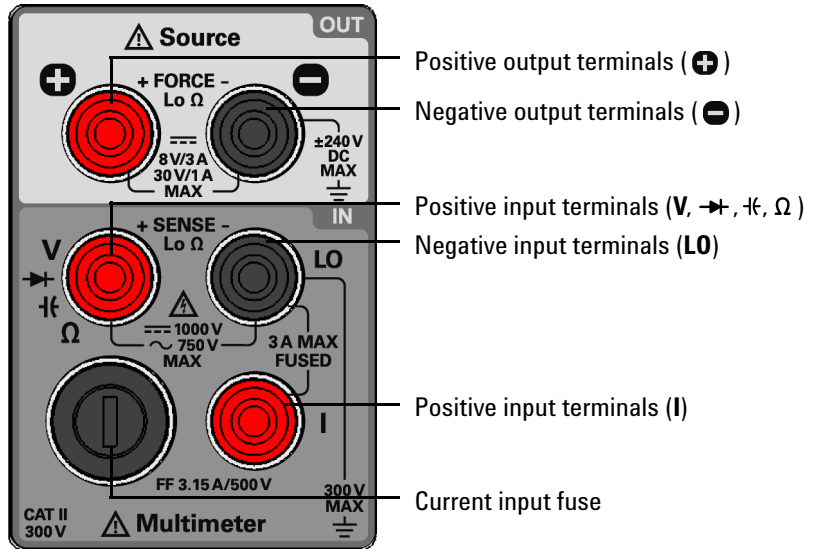





Figure 1-9 The input/output terminals at a glance

Table 1-5 Input terminal connections

Function	Input terminals (+ SENSE -)		Input protection
DC voltage measurement			1000 V _{rms} on all ranges
AC voltage measurement	V	LO	750 V _{rms} on all ranges
Frequency, duty cycle, and pulse width measurement via the voltage path			
Capacitance measurement		LO	1000 V _{rms} on all ranges, < 0.3 A short circuit
Diode test		LO	1000 V _{rms} on all ranges, < 0.3 A short circuit
Resistance (2-wire) measurement	Ω	LO	1000 V _{rms} on all ranges, < 0.3 A short circuit
Continuity test			
Low-resistance (4-wire) measurement	Ω	LO	1000 V _{rms} on all ranges, < 0.3 A short circuit
			3.15 A/250 V FF fuse
DC current measurement			
AC current measurement	I	LO	3.15 A/500 V FF fuse
Frequency, duty cycle, and pulse width measurements via the current path			



1 Introduction

The U3606B in Brief

Table 1-6 Output terminal connections

Function	Output terminals (+ FORCE -)		Maximum output
Constant voltage output	+	-	<ul style="list-style-type: none"> • Amplitude: 0 V to 30 V^[1] • OCP <ul style="list-style-type: none"> • S1: 0 A to 1.1 A • S2: 0 A to 3.3 A • S2m: 0 A to 3.3 A • S1S2: 0 A to 3.3 A • OC: <ul style="list-style-type: none"> • S1: 0 A to 1.05 A • S2: 0 A to 3.15 A • S2m: 0 A to 3.15 A • S1S2: 0 A to 3.15 A
Constant current output	+	-	<ul style="list-style-type: none"> • Amplitude: 0 A to 3 A^[2] • OVP: <ul style="list-style-type: none"> • S1: 0 V to 33 V • S2: 0 V to 8.8 V • S1m: 0 V to 33 V • S1S2: 0 V to 33 V • OV: <ul style="list-style-type: none"> • S1: 0 V to 31.5 V • S2: 0 V to 8.4 V • S1m: 0 V to 31.5 V • S1S2: 0 V to 31.5 V
Ramp output	+	-	<ul style="list-style-type: none"> • Amplitude: <ul style="list-style-type: none"> • CV: 0 V to 31.5 V^[1] • CC: 0 A to 3.15 A^[2] • Number of steps: 1 to 10000 steps
Scan output	+	-	<ul style="list-style-type: none"> • Amplitude: <ul style="list-style-type: none"> • CV: 0 V to 31.5 V^[1] • CC: 0 A to 3.15 A^[2] • Number of steps: 1 to 100 steps • Dwelling time: 1 to 99 s

Table 1-6 Output terminal connections (continued)

Function	Output terminals (+ FORCE -)		Maximum output
Square-wave output			<ul style="list-style-type: none"> • Amplitude: 0 V to 30 V^[1] • Frequency: Multiple predefined values^[3] • Duty cycle: 256 steps • Pulse width: 256 steps

[1] Limited by range selected, S1 (30 V/1 A), S2 (8 V/3 A), S2m (1000 mV/3 A), or S1S2 (autoranging).

[2] Limited by range selected, S1 (30 V/1 A), S1m (30 V/100 mA), S2 (8 V/3 A), or S1S2 (autoranging).

[3] Frequency range: 0.5 Hz to 4800 Hz if S1 or S2 is selected, 10 Hz to 4800 Hz (with fixed 50% duty cycle) if S1S2 (autoranging) is selected.

1 Introduction
The U3606B in Brief

THIS PAGE HAS BEEN INTENTIONALLY LEFT BLANK.

2 Operation and Features

Measuring Voltage	30
Measuring Current	33
Measuring Resistance	36
Testing Continuity	39
Measuring Low-Resistance	42
Measuring Capacitance	47
Testing Diodes	50
Measuring Frequency/Pulse Width/Duty Cycle (Voltage Path)	53
Measuring Frequency/Pulse Width/Duty Cycle (Current Path)	56
Selecting a Range	59
Setting the Resolution	61
Math Operations	62
Null	63
dBm measurements	66
dB measurements	67
MinMax	69
Limit	70
Hold	73
Triggering the Multimeter	75
Front panel triggering	76
Remote interface triggering	77

This chapter describes the various multimeter functions and features available in the U3606B.

2 Operation and Features

Measuring Voltage

Measuring Voltage

Connect the test leads

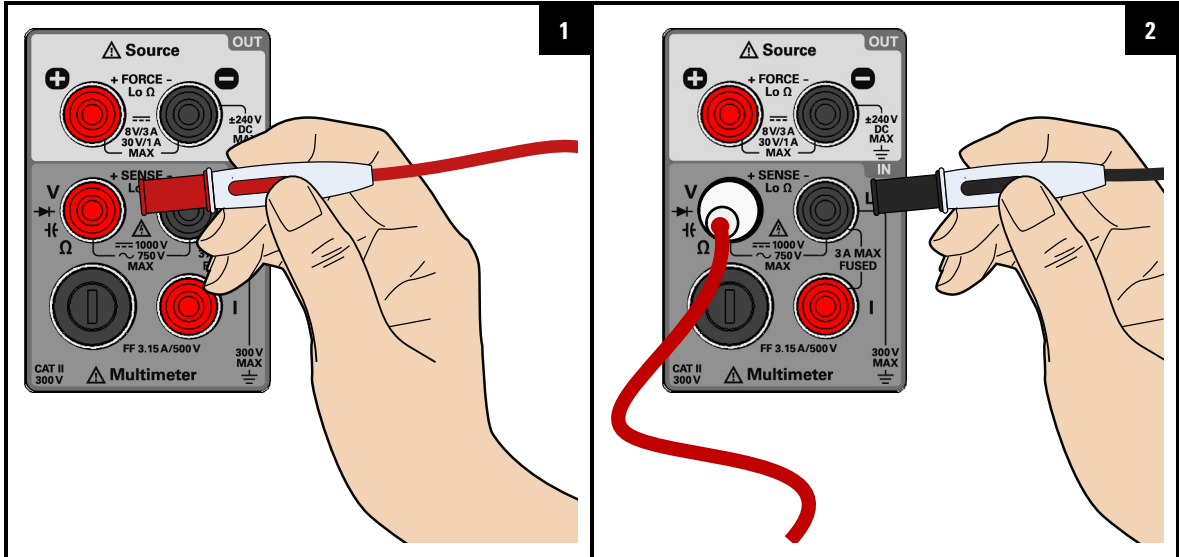

Select the voltage measurement function

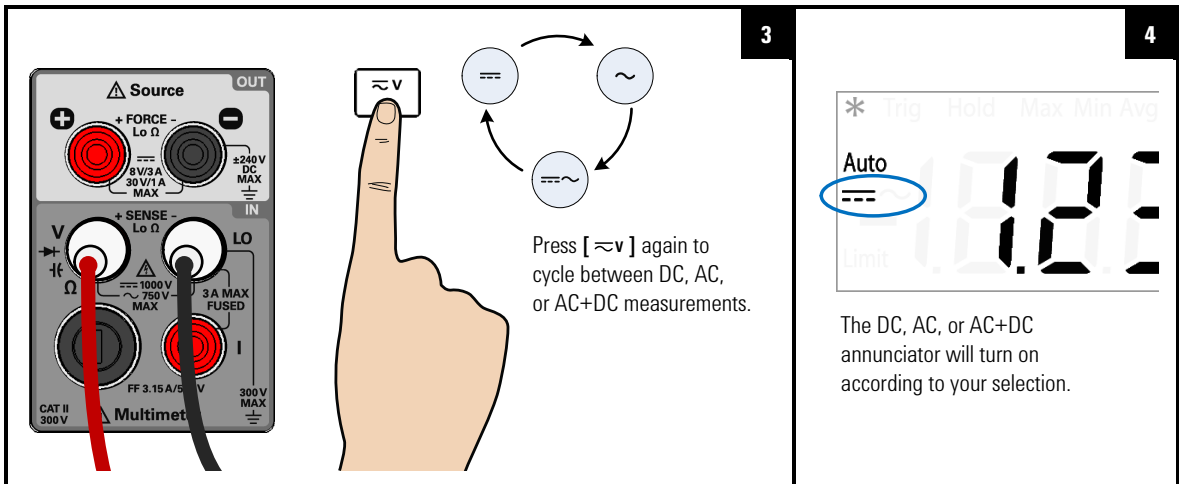

Probe the test points and read the display

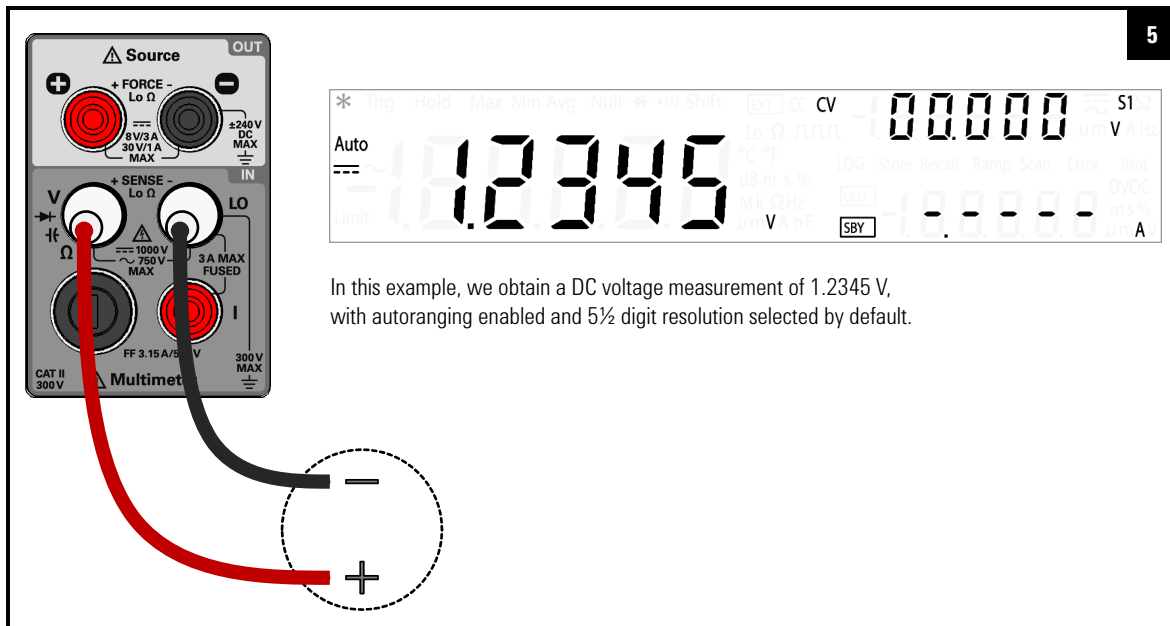

In this example, we obtain a DC voltage measurement of 1.2345 V, with autoranging enabled and 5½ digit resolution selected by default.

Voltage measurement summary

Table 2-1 Voltage measurement summary

Item	Description
DC voltage measurement	
Available ranges	19.9999 mV, 100.000 mV, 1.00000 V, 10.0000 V, 100.000 V, 1000.00 V
Measurement method	Sigma Delta A-to-D converter
Input impedance	10 MΩ ± 2% range (typical) in parallel with capacitance < 120 pF
Input protection	1000 V _{rms} on all ranges

2 Operation and Features

Measuring Voltage

Table 2-1 Voltage measurement summary (continued)

Item	Description
AC voltage measurement	
Available ranges	100.000 mV, 1.00000 V, 10.0000 V, 100.000 V, 750.00 V
Measurement method	AC coupled true rms
Input impedance	1 M Ω \pm 2% range (typical) in parallel with capacitance < 120 pF
Input protection	750 V _{rms} on all ranges
Crest factor	For < 5:1 errors included. Limited by the peak input and 100 kHz bandwidth. Maximum 3.0 at full scale.
Peak input	300% of range. Limited by maximum input.

NOTE

Using the AC+DC function

The U3606B is a true-rms multimeter that returns an accurate rms reading not only for sine waves, but also other AC signals such as square, triangle, and staircase waveforms without any DC offset. However, you may choose to return the measured AC signal *with* its DC offset by using the AC+DC function.

Measuring Current

Connect the test leads

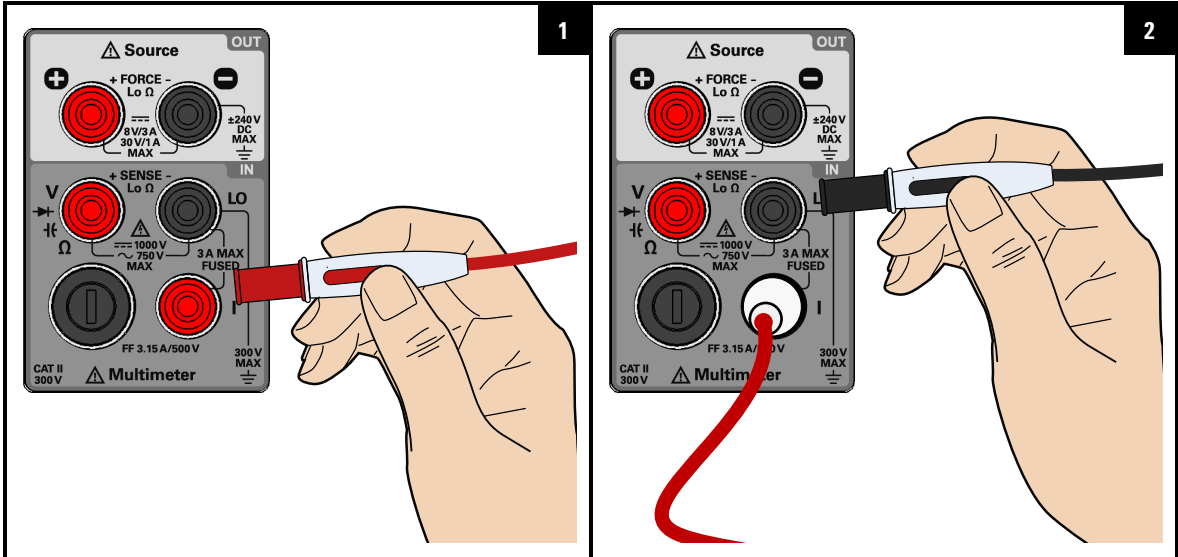

Select the current measurement function

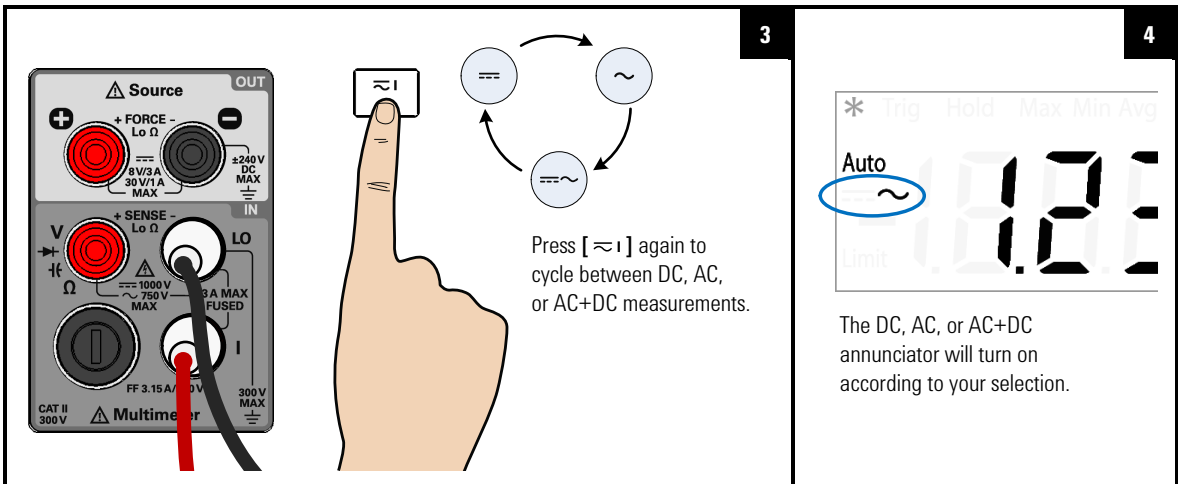

2 Operation and Features

Measuring Current

Probe the test points and read the display

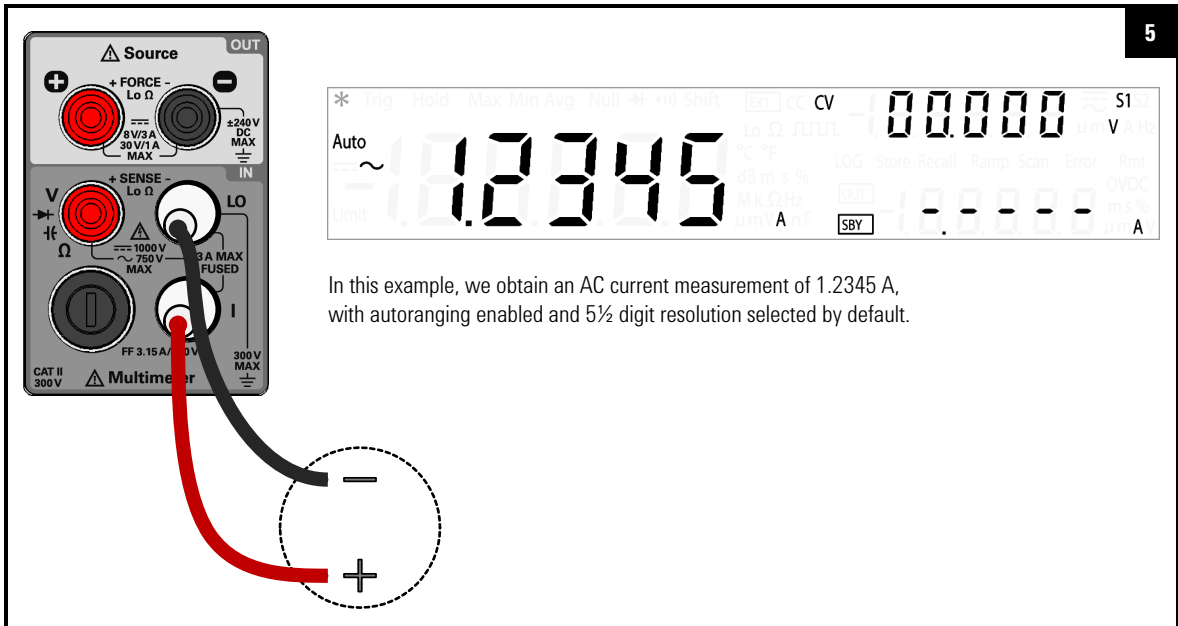

Current measurement summary

Table 2-2 Current measurement summary

Item	Description
DC current measurement	
Available ranges	10.0000 mA, 100.000 mA, 1.00000 A, 3.0000 A
Measurement method	Sigma Delta A-to-D converter
Burden voltage and shunt resistance	<ul style="list-style-type: none"> < 0.2 V, 10 Ω for 10 mA range < 0.2 V, 1 Ω for 100 mA range < 0.3 V, 0.05 Ω for 1 A range < 0.7 V, 0.05 Ω for 3 A range
Input protection	Protected with a 3.15 A/500 V, FF fuse

Table 2-2 Current measurement summary (continued)

Item	Description
AC current measurement	
Available ranges	10.0000 mA, 100.000 mA, 1.00000 A, 3.0000 A
Measurement method	AC coupled true rms
Burden voltage and shunt resistance	<ul style="list-style-type: none"> • < 0.2 V/10 Ω for 10 mA range • < 0.2 V/1 Ω for 100 mA range • < 0.3 V/0.05 Ω for 1 A range • < 0.7 V/0.05 Ω for 3 A range
Input protection	Protected with a 3.15 A/500 V, FF fuse
Crest factor	For < 5:1 errors included. Limited by the peak input and 100 kHz bandwidth. Maximum 3.0 at full scale.
Peak input	300% of range. Limited by maximum input.

NOTE

Using the AC+DC function

The U3606B is a true-rms multimeter that returns an accurate rms reading not only for sine waves, but also other AC signals such as square, triangle, and staircase waveforms without any DC offset. However, you may choose to return the measured AC signal *with* its DC offset by using the AC+DC function.

2 Operation and Features

Measuring Resistance

Measuring Resistance

Connect the test leads

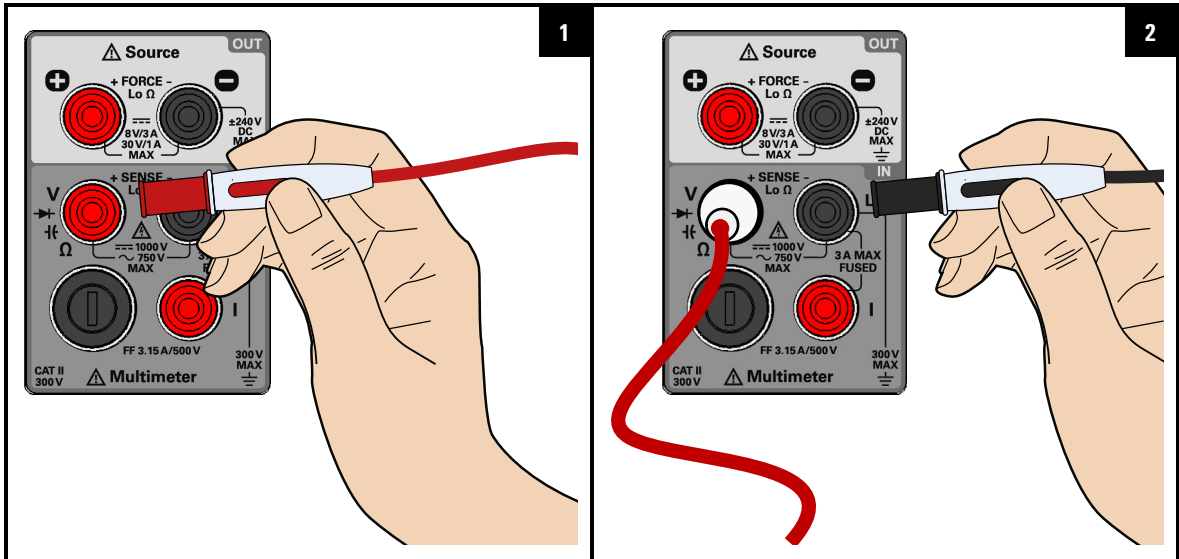

Select the resistance measurement function

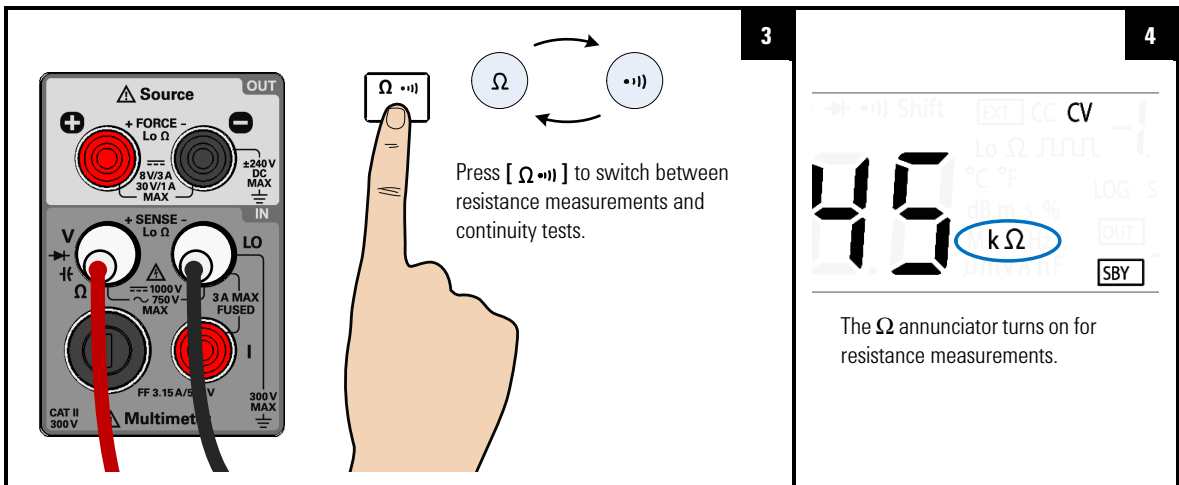

Probe the test points and read the display

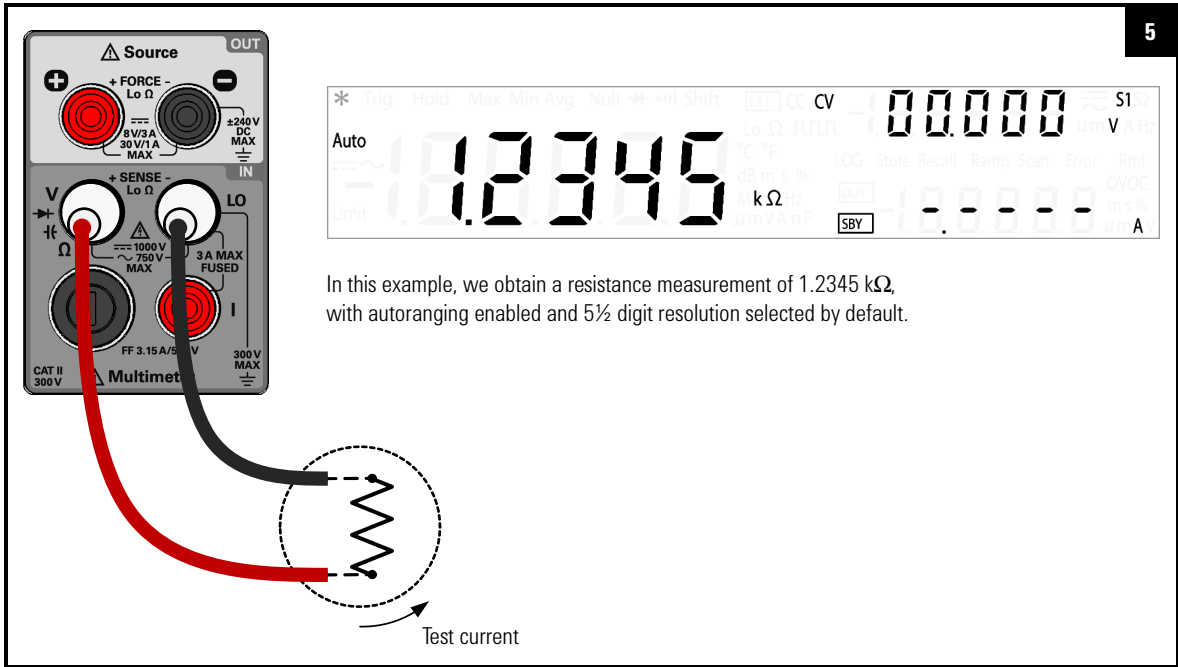

In this example, we obtain a resistance measurement of 1.2345 kΩ, with autoranging enabled and 5½ digit resolution selected by default.

CAUTION

Disconnect circuit power and discharge all high-voltage capacitors before measuring resistance or conductance, or testing circuit continuity, to avoid damaging the U3606B or the device under test.

2 Operation and Features

Measuring Resistance

Resistance measurement summary

Table 2-3 Resistance measurement summary

Item	Description
Available ranges	100.000 Ω , 1.00000 k Ω , 10.0000 k Ω , 100.000 k Ω , 1.00000 M Ω , 10.0000 M Ω , 100.000 M Ω
Measurement method	Two-wire, open-circuit voltage limited to < 5 V
Input protection	1000 V _{rms} on all ranges, < 0.3 A short circuit

Testing Continuity

Connect the test leads

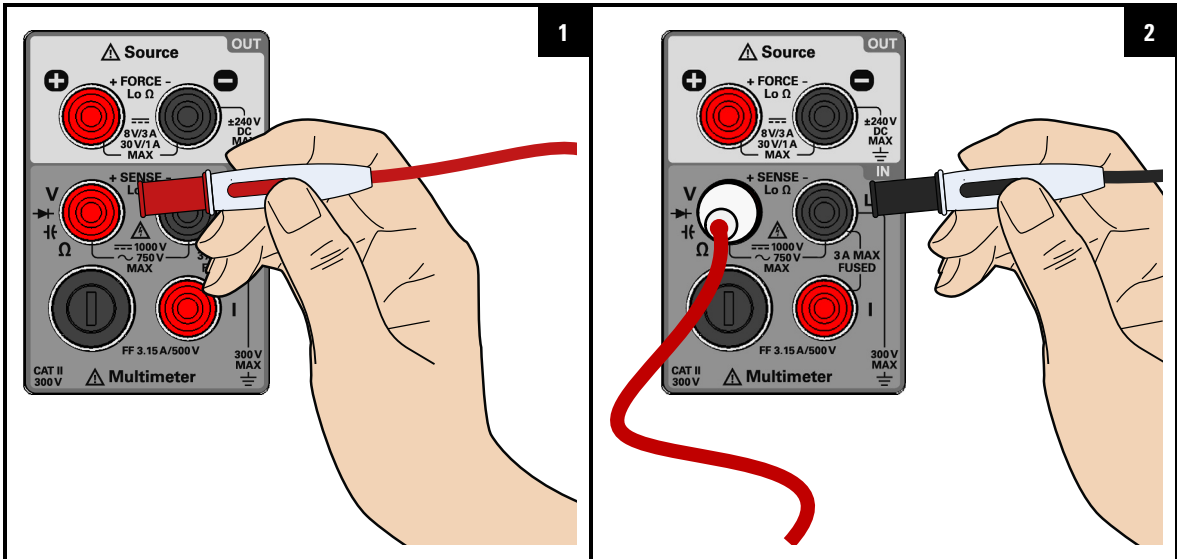

Select the continuity test function

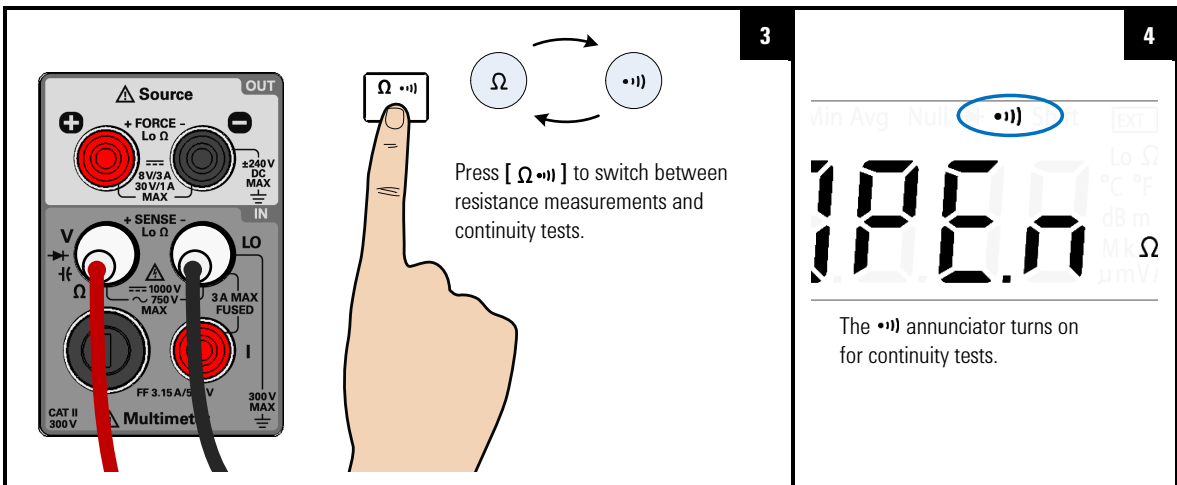

2 Operation and Features

Testing Continuity

Probe the test points and read the display

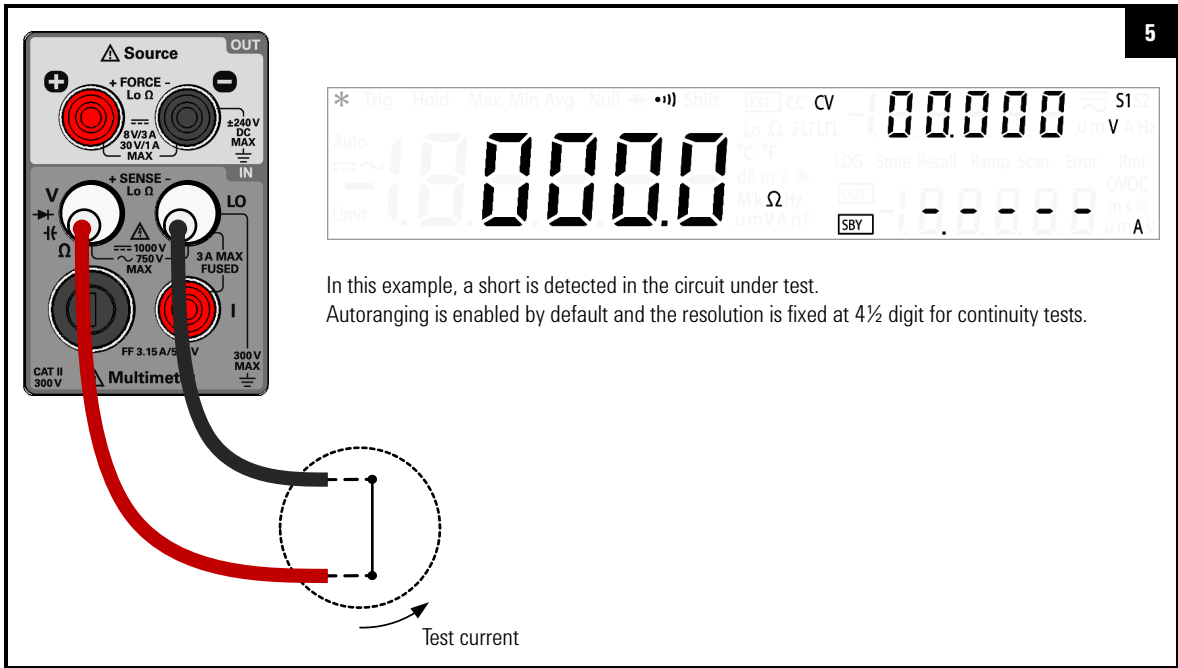

CAUTION

Disconnect circuit power and discharge all high-voltage capacitors before measuring resistance or conductance, or testing circuit continuity, to avoid damaging the U3606B or the device under test.

NOTE

Beeps when a short is detected

The U3606B beeps when the continuity measurement is less than or equal to the continuity threshold. This allows you to quickly determine shorts in the circuit under test without having to look at the display.

Continuity test summary

Table 2-4 Continuity test summary

Item	Description
Measurement method	0.83 mA \pm 0.2% constant current source, open-circuit voltage limited to < 5 V
Audible tone	Continuous beep when reading is less than threshold resistance of 10 Ω at 1.0 k Ω range
Input protection	1000 V _{rms} on all ranges, < 0.3 A short circuit

2 Operation and Features

Measuring Low-Resistance

Measuring Low-Resistance

Connect the test leads

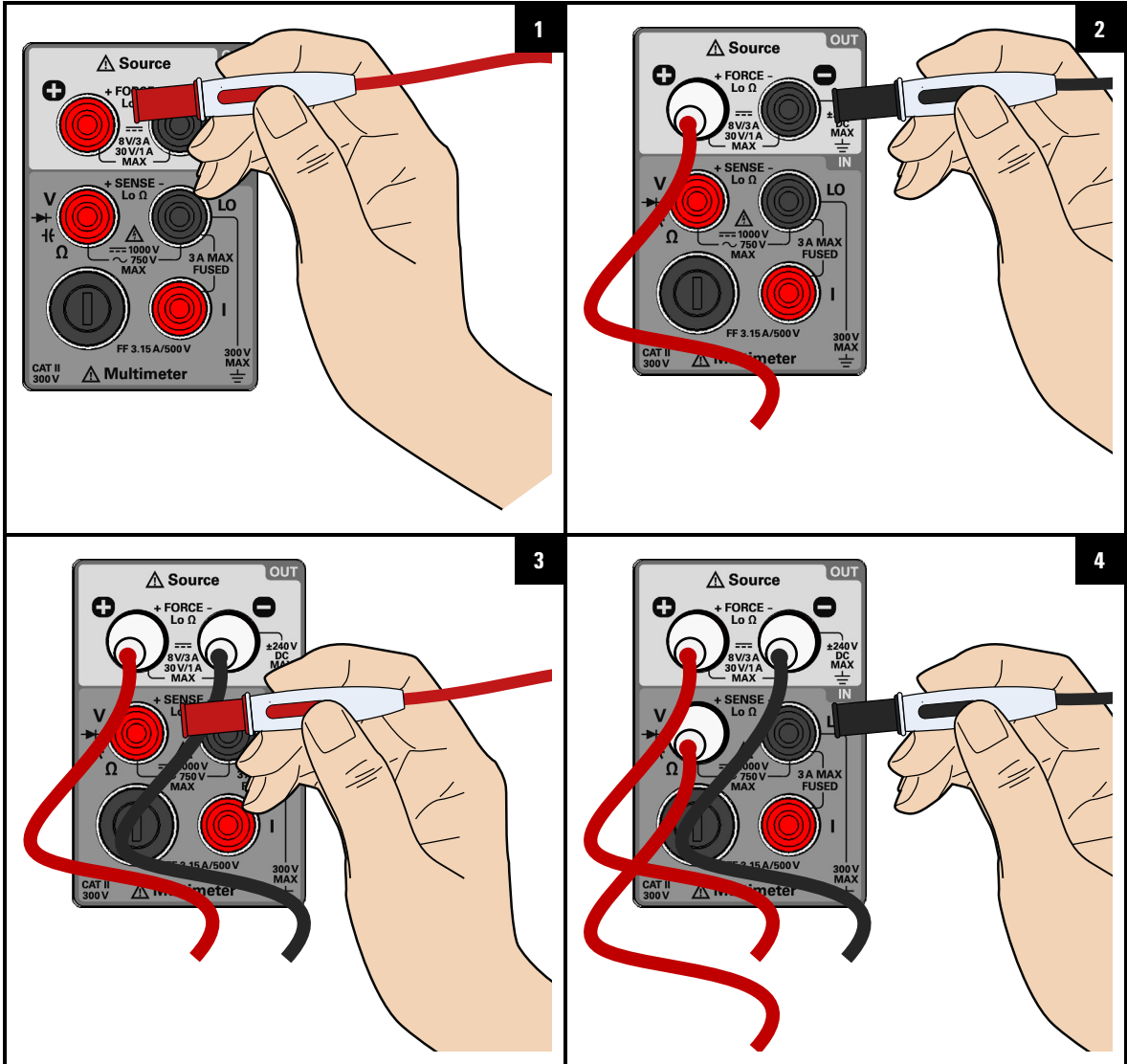

Select the low-resistance measurement function

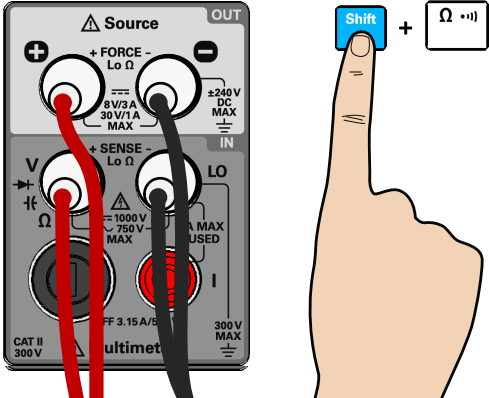

The diagram shows the multimeter terminals: Source (OUT), FORCE - Lo Ω, SENSE - Lo Ω, and IN. A hand is shown pressing the Shift key, which is labeled with a blue box and the text "Shift + Ω ·Ω".

5

6

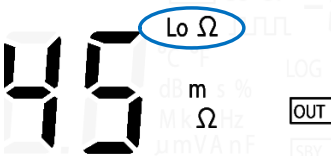

The digital display shows the number "45" and the "Lo Ω" annunciator is turned on. The display also shows "m Ω" and "OUT".

The Lo Ω annunciator turns on for low-resistance measurements.

Probe the test points and read the display

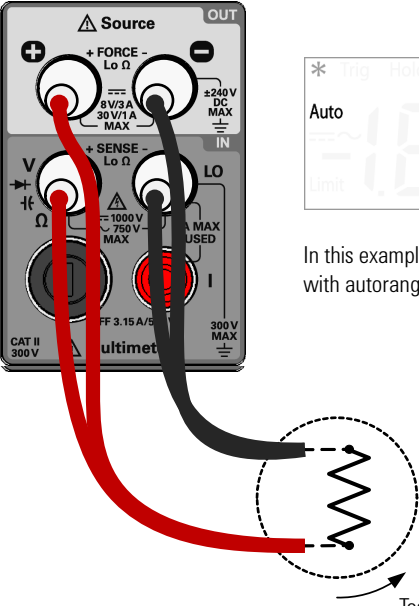

The diagram shows the multimeter terminals and test leads connected to a resistor. The test current is indicated by an arrow pointing to the resistor.

7

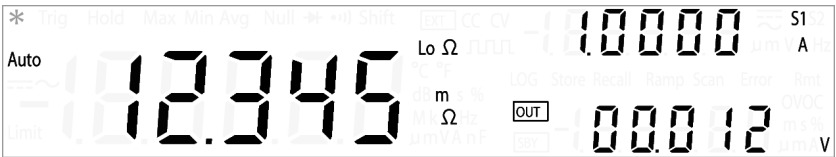

The digital display shows the number "12.345" and the "Lo Ω" annunciator is turned on. The display also shows "m Ω" and "OUT".

In this example, we obtain a resistance measurement of 12.345 mΩ, with autoranging enabled and 5½ digit resolution selected by default.

CAUTION: The load wattage must be able to handle the applied current.

2 Operation and Features

Measuring Low-Resistance

CAUTION

Disconnect circuit power and discharge all high-voltage capacitors before measuring resistance or conductance, or testing circuit continuity, to avoid damaging the U3606B or the device under test.

NOTE

DC power supply functions are locked

The DC power supply functions are locked when you select the low-resistance (Lo Ω) measurements. You cannot use the DC power supply module simultaneously with the digital multimeter module when you are measuring 4-wire low-resistance measurements.

To unlock the DC power supply functions, exit the low-resistance (Lo Ω) measurement by selecting another multimeter measurement.

NOTE

Delayed response for low-resistance readings

For measuring low-resistance, a delayed response should be expected from the front panel display. For remote interface operation, increase the SCPI query time-out value (typically 15000 ms).

Low-resistance measurement summary

Table 2-5 Low-resistance measurement summary

Item	Description
Available ranges	100 m Ω , 1000 m Ω , 10 Ω , 100 Ω , 1000 Ω
Measurement method	Four-wire, the test current is sent from the FORCE terminals and the resistance is measured by the SENSE terminals.
Input protection	<ul style="list-style-type: none">• FORCE terminals: Protected with a 3.15 A/250 V FF fuse• SENSE terminals: 1000 V_{rms} on all ranges, < 0.3 A short circuit

Table 2-6 Low-resistance test current values^[1]

Range	Detection current	Test current ^[2]			
		Default	Range	Min	Max
100 mΩ	0.015 A	1.0000 A	S2 (A)	1.0000 A	3.0000 A
1000 mΩ	0.015 A	0.1000 A	S1 (A)	0.1000 A	0.3000 A
10 Ω	X mA ^[3]	50.0 mA	S1 (mA)	50.0 mA	100.0 mA
100 Ω	X mA ^[3]	10.0 mA	S1 (mA)	4.0 mA	30.0 mA
1000 Ω	X mA ^[3]	6.0 mA	S1 (mA)	4.0 mA	10.0 mA

[1] When the display shows “OL”, always apply the detection current.

[2] Press [**Current**] to change the test current selected (see [page 46](#)).

[3] “X” follows the test current setting of 1000 Ω range.

2 Operation and Features

Measuring Low-Resistance

Changing the low-resistance test current

Enable the low-resistance function first.

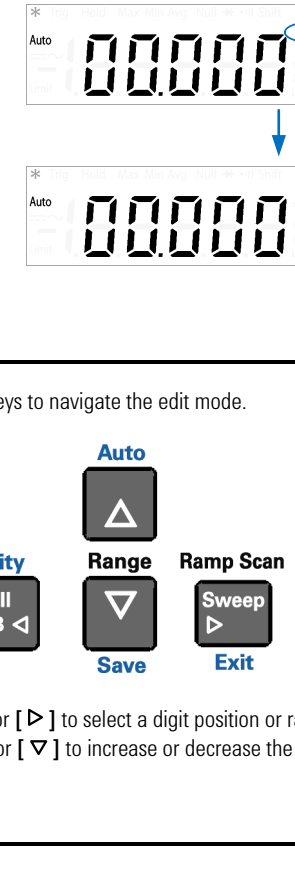

1

Use the arrow keys to navigate the edit mode.

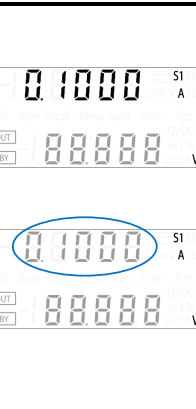

- Press [<] or [>] to select a digit position or range.
- Press [Δ] or [▽] to increase or decrease the value selected.

2

To save the changes

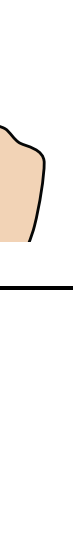

3a

To exit the edit mode without saving

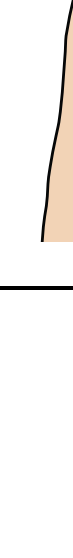

3b

Measuring Capacitance

Connect the test leads

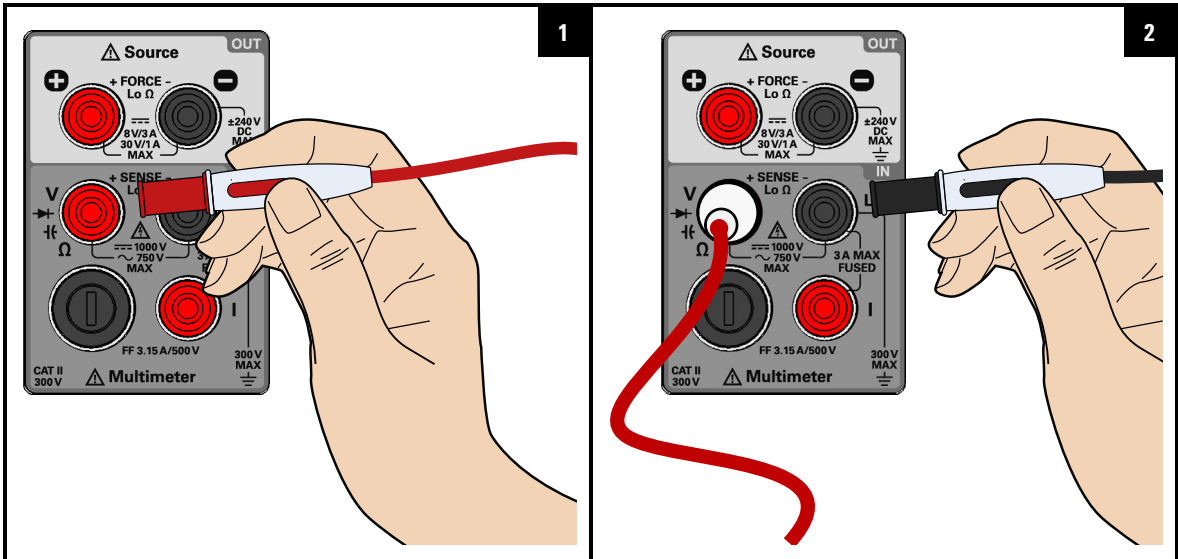

Select the capacitance measurement function

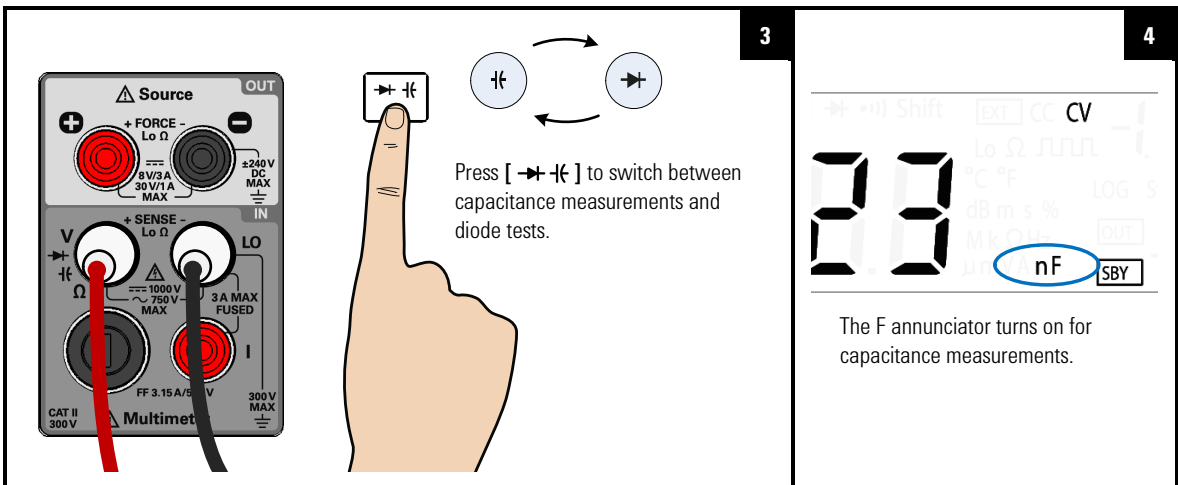

2 Operation and Features

Measuring Capacitance

Probe the test points and read the display

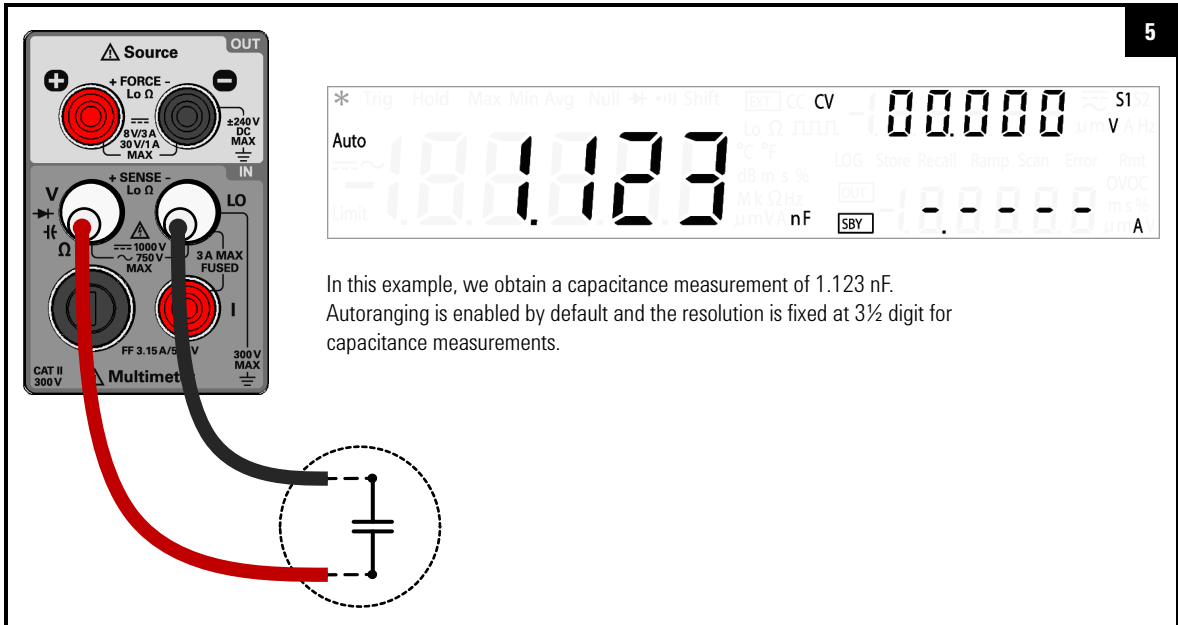

CAUTION

Disconnect circuit power and discharge all high-voltage capacitors before measuring capacitance to avoid damaging the U3606B or the device under test. To confirm that a capacitor has fully discharged, use the DC voltage measurement.

NOTE

Measuring tips

- The U3606B calculates capacitance by charging a capacitor with a known current for a period of time and then measuring the voltage.
- For measuring capacitance values greater than 10000 μF , discharge the capacitor first, then select a suitable range for measurement. This will speed up the measurement time and also ensure that the correct capacitance value is obtained.
- For measuring capacitance values greater than 1 mF, a delayed response should be expected from the front panel display. For remote interface operation, increase the SCPI query time out value. (Typically > 10000 ms.)
- For measuring small capacitance values, press **[Null]** with the test leads open to subtract the residual capacitance of the instrument and leads.

Capacitance measurement summary

Table 2-7 Capacitance measurement summary

Item	Description
Available ranges	1 nF, 10 nF, 100 nF, 1 μF , 10 μF , 100 μF , 1000 μF , 10000 μF
Measurement method	Computed from constant current source charge time, typical 0.2 V to 1.4 V signal level
Input protection	1000 V_{rms} on all ranges, < 0.3 A short circuit

2 Operation and Features

Testing Diodes

Testing Diodes

Connect the test leads

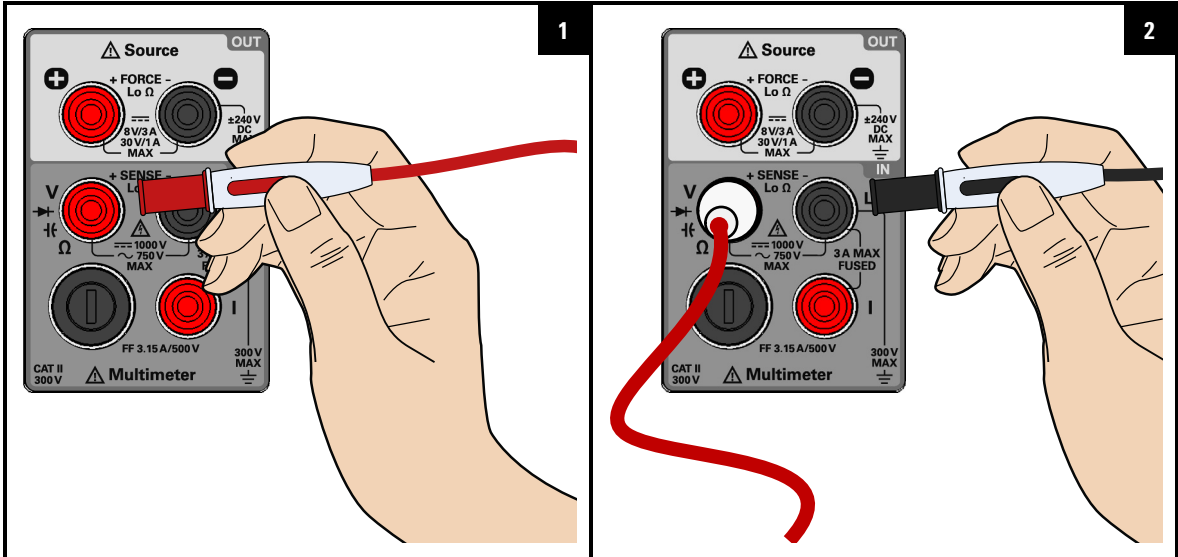

Select the diode test function

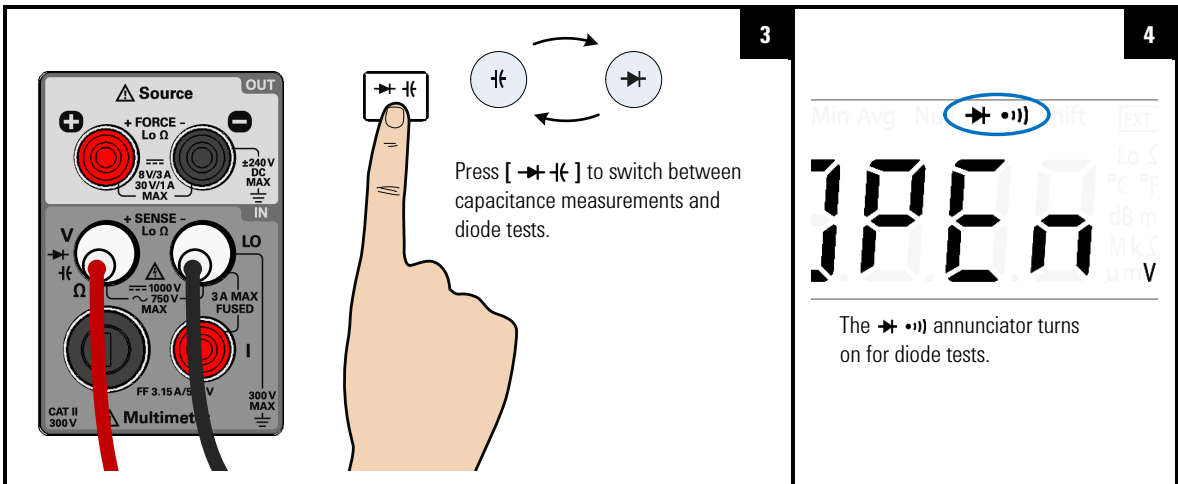

Probe the test points and read the display

5

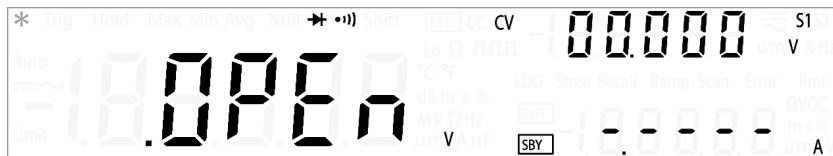
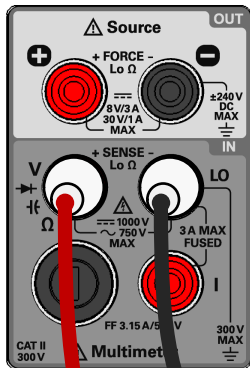

In this example, we obtain an open result from a reverse-bias diode. This response indicates that the diode is good.

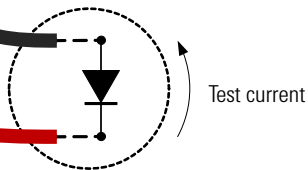

6

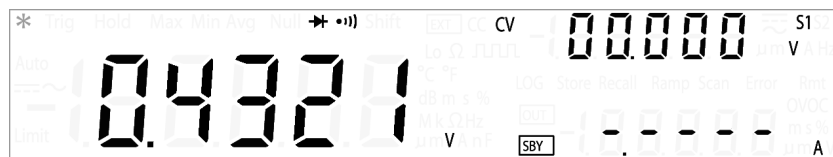
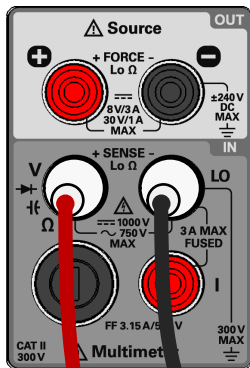

In this example, we obtain a voltage measurement of 0.4321 V from a forward-bias diode. This response indicates that the diode is good. The resolution is fixed at 4½ digit for diode tests.

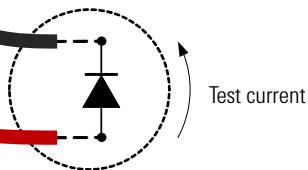

2 Operation and Features

Testing Diodes

CAUTION

Disconnect circuit power and discharge all high-voltage capacitors before checking diodes to avoid damaging the U3606B or the device under test.

NOTE

Testing tips

- To measure forward-bias diode, connect the other end of the red test lead to the positive terminal (anode) of the diode and the black test lead to the negative terminal (cathode). The cathode of a diode is indicated with a band.
- The U3606B can display diode forward bias of up to approximately 1.2 V. The forward bias of a typical diode is within the range of 0.3 V to 0.8 V.
- A diode is considered good if the multimeter displays OPEn in reverse bias mode.
- A diode is considered shorted if the multimeter displays approximately 0 V in both forward and reverse bias modes, and the U3606B beeps continuously.
- A diode is considered open if the multimeter displays OPEn in both forward and reverse bias modes.

Diode test summary

Table 2-8 Diode test summary

Item	Description
Measurement method	0.83 mA \pm 0.2% constant current source
Audible tone	<ul style="list-style-type: none">• Continuous beep when level is below +50 mV DC• Single tone for normal forward-biased diode or semiconductor junction where $0.3\text{ V} \leq \text{reading} \leq 0.8\text{ V}$
Input protection	1000 V _{rms} on all ranges, < 0.3 A short circuit

Measuring Frequency/Pulse Width/Duty Cycle (Voltage Path)

Connect the test leads

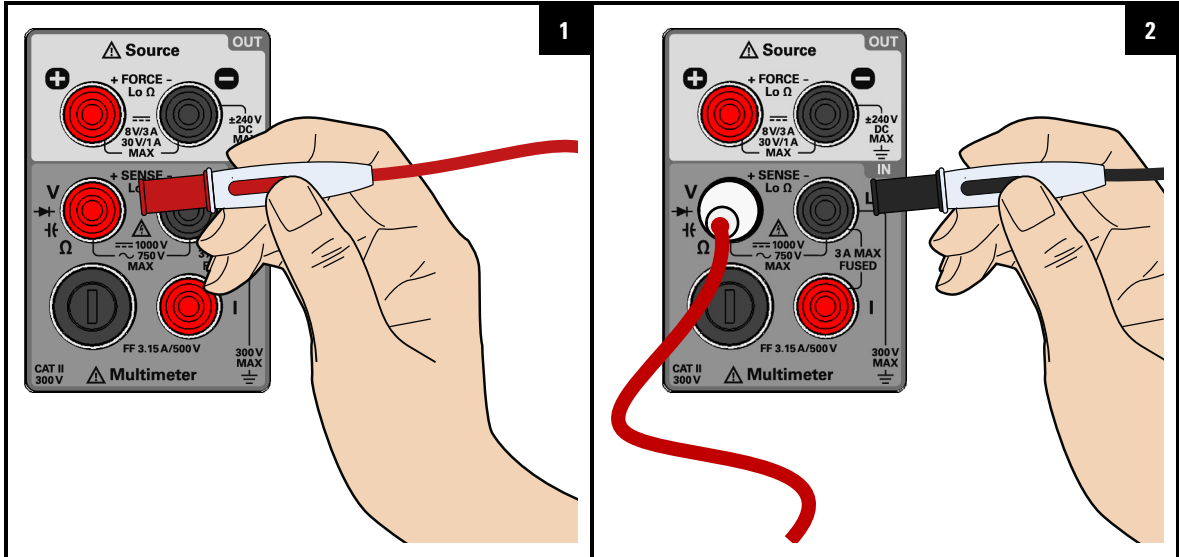

Select the frequency measurement function

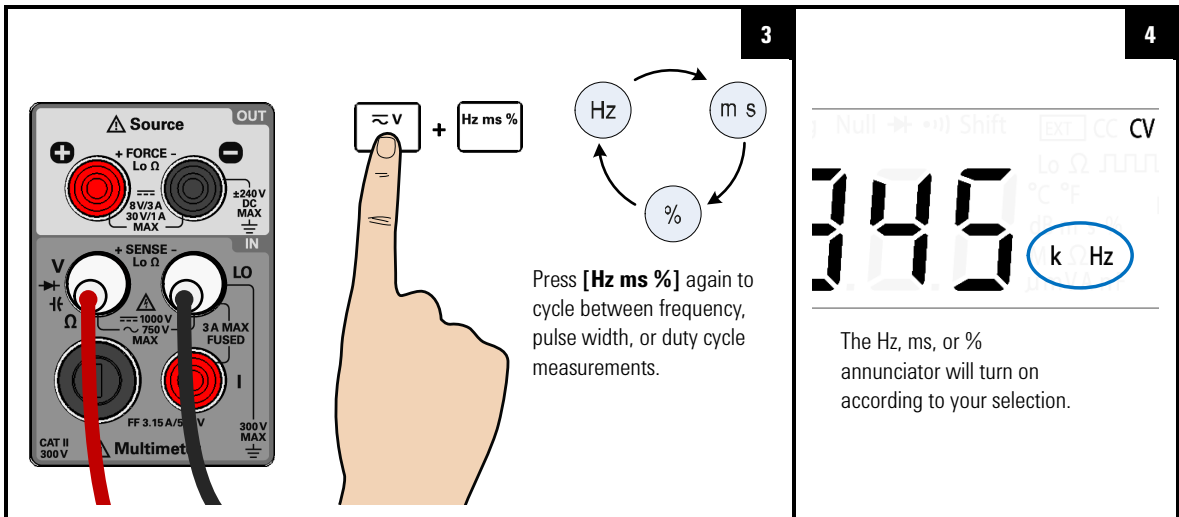

2 Operation and Features

Measuring Frequency/Pulse Width/Duty Cycle (Voltage Path)

Probe the test points and read the display

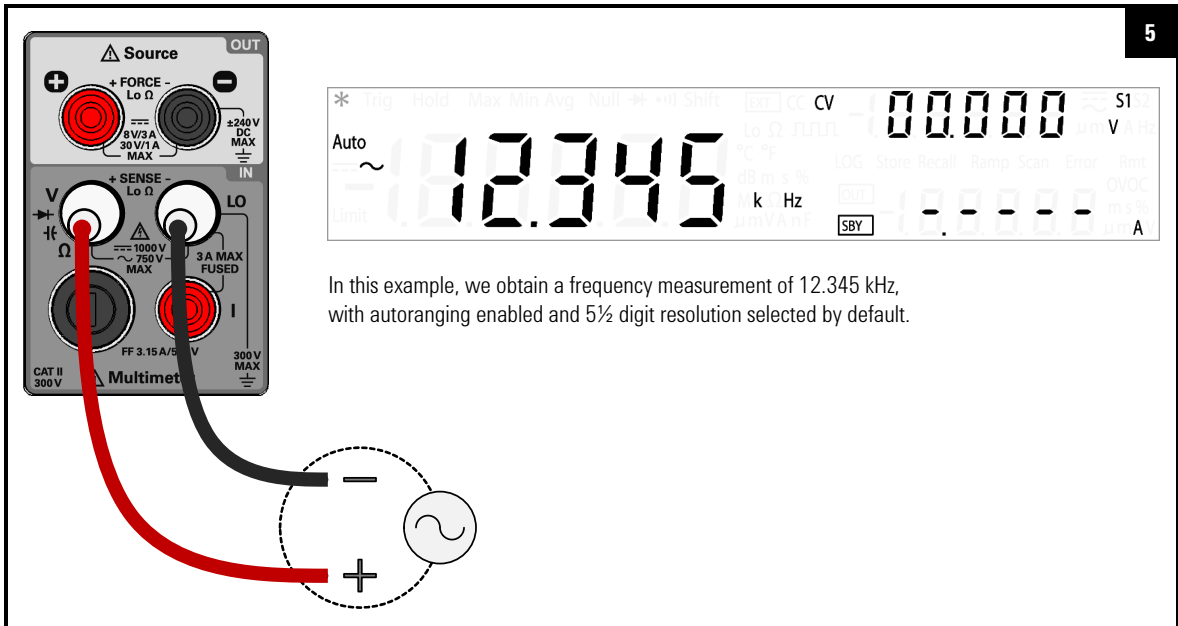

CAUTION

If the frequency signal measured is below 20 Hz, you must manually set the range of the AC voltage or AC current measurement to acquire a stable reading.

NOTE

- The range and resolution of the frequency, pulse width, and duty cycle measurement follows the configuration of the AC voltage or AC current measurement (dependent on the path chosen).
- The AC voltage or AC current measurement display will flash briefly before the frequency measurement display is shown.

Frequency/pulse width/duty cycle measurement (voltage path) summary

Table 2-9 Frequency/pulse width/duty cycle measurement (voltage path) summary

Item	Description
Available ranges	100.000 mV, 1.00000 V, 10.0000 V, 100.000 V, 750.00 V — range is based on the voltage level of the signal, not frequency
Measurement method	Reciprocal counting technique
Signal level	10% of range to full scale input on all ranges
Input protection	750 V _{rms} on all ranges

2 Operation and Features

Measuring Frequency/Pulse Width/Duty Cycle (Current Path)

Measuring Frequency/Pulse Width/Duty Cycle (Current Path)

Connect the test leads

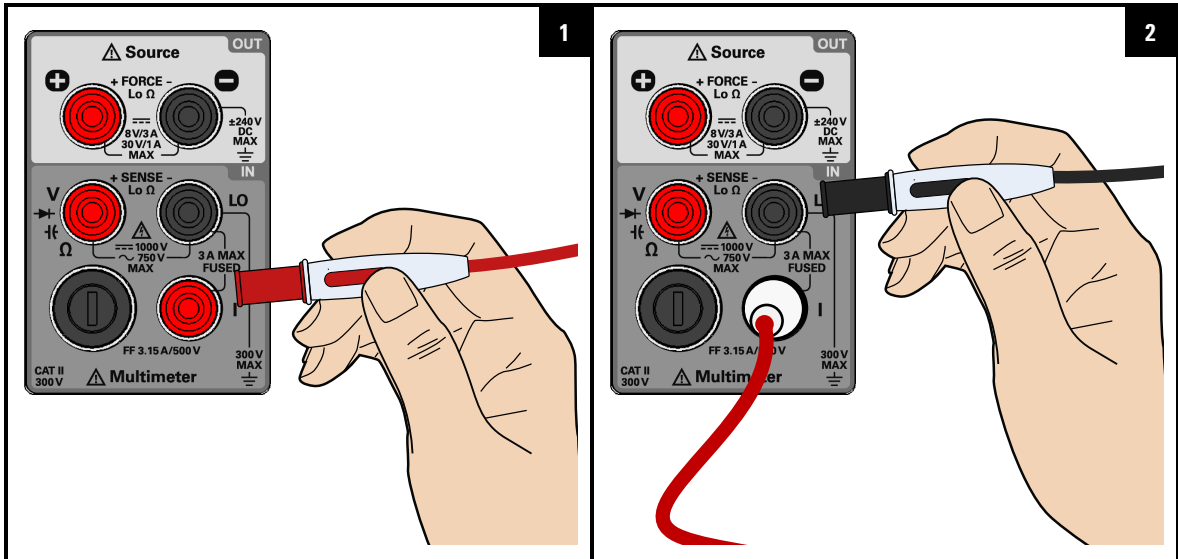

Select the frequency measurement function

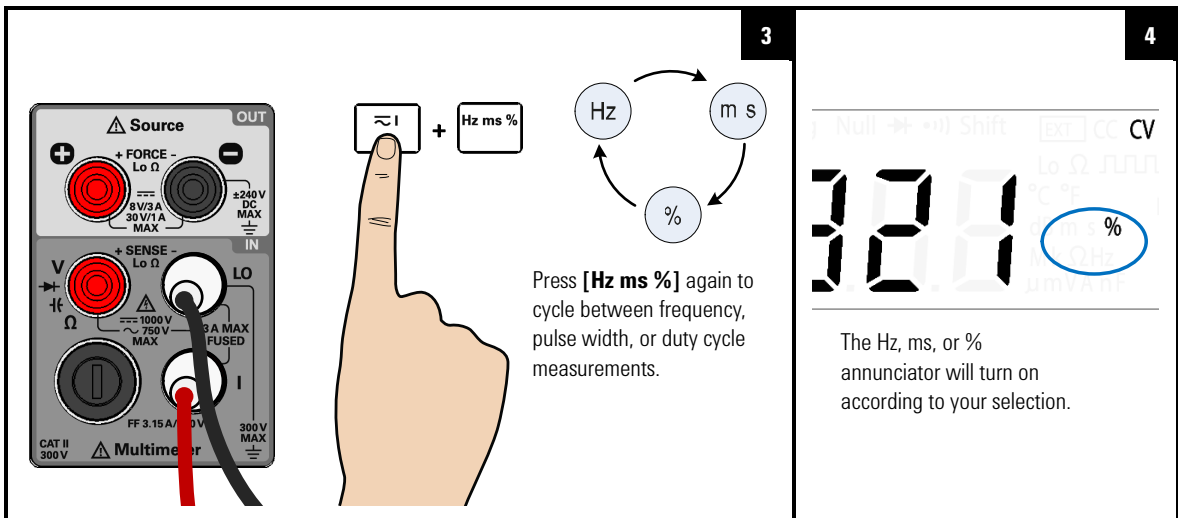

Probe the test points and read the display

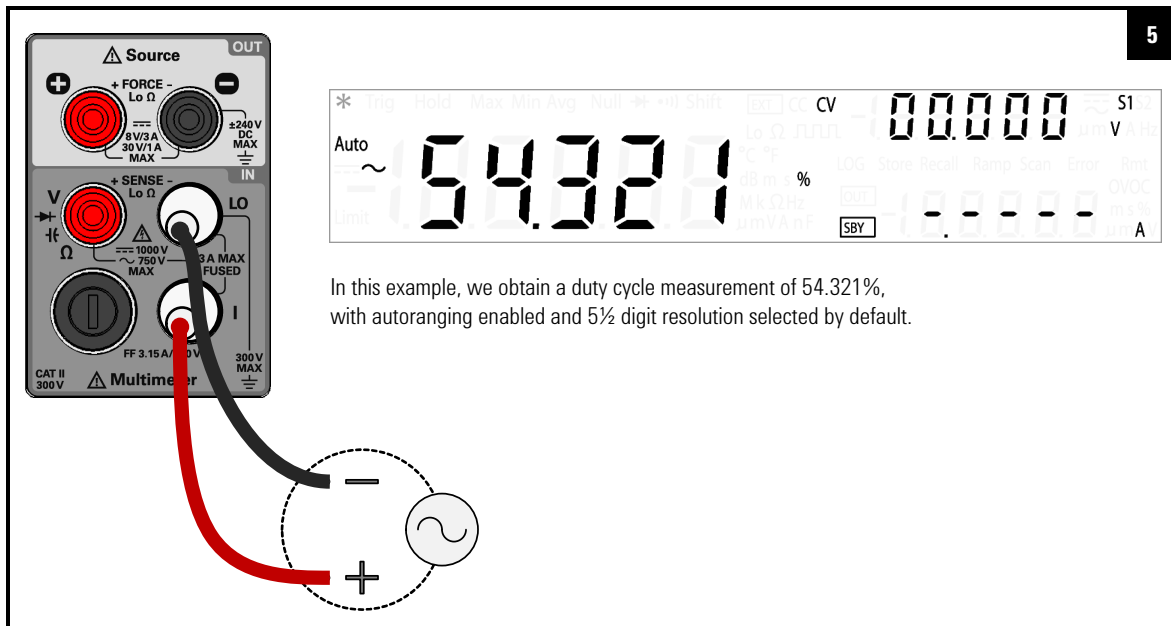

In this example, we obtain a duty cycle measurement of 54.321%, with aut-ranging enabled and 5½ digit resolution selected by default.

CAUTION

If the frequency signal measured is below 20 Hz, you must manually set the range of the AC voltage or AC current measurement to acquire a stable reading.

NOTE

- The range and resolution of the frequency, pulse width, and duty cycle measurement follows the configuration of the AC voltage or AC current measurement (dependent on the path chosen).
- The AC voltage or AC current measurement display will flash briefly before the frequency measurement display is shown.

2 Operation and Features

Measuring Frequency/Pulse Width/Duty Cycle (Current Path)

Frequency/pulse width/duty cycle measurement (current path) summary

Table 2-10 Frequency /pulse width/duty cycle measurement (current path) summary





Item	Description
Available ranges	10.0000 mA, 100.000 mA, 1.00000 A, 3.0000 A — range is based on the current level of the signal, not frequency
Measurement method	Reciprocal counting technique
Signal level	10% of range to full scale input on all ranges
Input protection	Protected with a 3.15 A/500 V, FF fuse

Selecting a Range

You can allow the U3606B to automatically select the range using autoranging (default setting), or you can select a fixed range using manual ranging.

NOTE

- Autoranging is convenient because the U3606B automatically selects the appropriate range for sensing and displaying each measurement.
- However, manual ranging results in better performance, since the U3606B does not have to determine which range to use for each measurement.

Key	Description
	Press [Δ] to select a higher range and disable autoranging.
Range 	Press [∇] to select a lower range and disable autoranging.
 Shift  Auto	Press [Shift] > [Auto] to toggle between autoranging and manual ranging.

2 Operation and Features

Selecting a Range

NOTE

- Autoranging is selected at default factory power-on and after a remote reset.
- Manual ranging — If the input signal is greater than can be measured on the selected range, the multimeter provides these overload indications: “+/- OL” from the front panel or “±9 . 9E+37” from the remote interface.
- For frequency, pulse width, and duty cycle measurements, ranging applies to the input voltage or input current of the signal, not its frequency.
- The range is fixed for diode ($1 V_{dc}$ range) tests.
- The U3606B remembers the selected ranging method (auto or manual) and the selected manual range for each measurement function.
- Autorange thresholds — The U3606B shifts ranges as follows:

Down range at < 10% of current range



Up range at > 120% of current range

Setting the Resolution

You can select either 4½ digit or 5½ digit resolution for the AC voltage, DC voltage, AC+DC voltage, AC current, DC current, AC+DC current, resistance, low-resistance, frequency, pulse width, and duty cycle measurements.

NOTE

- 5½ digit readings have the best accuracy and noise rejection.
- 4½ digit readings provide for faster readings.
- The range and resolution of the frequency, pulse width, and duty cycle measurements follows the configuration of the AC voltage or the AC current function.
- Continuity and diode tests have a fixed 4½ digit display.
- Capacitance measurements have a fixed 3½ digit display.

Key	Description
 	Press [Shift] > [4½ 5½] to toggle between 4½ digit and 5½ digit mode.

Math Operations

The U3606B provides six math operations: null measurements, dB measurements, dBm measurements, statistics (MinMax) for accumulated readings, limit testing, and a hold function. The table below describes the math operations that can be used with each measurement function.

Table 2-11 Math operations summary

Measurement function	Allowed math operation					
	Null	dBm	dB	Min Max	Limit	Hold
DC voltage	✓	✓	✓	✓	✓	✓
DC current	✓	-	-	✓	✓	✓
AC voltage	✓	✓	✓	✓	✓	✓
AC current	✓	-	-	✓	✓	✓
AC+DC voltage	✓	✓	✓	✓	✓	✓
AC+DC current	✓	-	-	✓	✓	✓
Resistance	✓	-	-	✓	✓	✓
Low-resistance	✓	-	-	✓	✓	✓
Frequency	✓	-	-	✓	✓	✓
Pulse width	✓	-	-	✓	✓	✓
Duty cycle	✓	-	-	✓	✓	✓
Capacitance	✓	-	-	✓	✓	✓
Continuity	-	-	-	-	-	-
Diode	-	-	-	-	-	-

NOTE

- All math operations can be toggled off by pressing **[Shift]** > **[Exit]**.
- All math operations are automatically turned-off when changing measuring functions.
- Range changing is allowed for all math operations except for the Hold function.
- For remote operation, refer to the **CALCulate** subsystem in the *U3606B Programmer's Reference*.

Null

When making null measurements, also called relative, each reading is the difference between a stored (selected or measured) null value and the input signal. One possible application is to increase the accuracy of a 2-wire resistance measurement by nulling the test lead resistance. Nulling the leads is also particularly important prior to making capacitance measurements. The formula used for calculating null measurements is:

$$result = reading - null\ value$$

The null value is adjustable. You can set it to any value between 0 and ±120% of the highest range, for the present function.

NOTE

- Null can be set for both auto and manual range settings, but not in the case of an overload.
- In resistance measurement, the U3606B will read a non-zero value even when the two test leads are in direct contact because of the resistance of these leads. Use the null function to zero-adjust the display.
- In DC voltage measurement mode, the thermal effect will influence the accuracy. Short the test leads and press **[Null]** once the displayed value is stable to zero-adjust the display.

2 Operation and Features

Math Operations

Enable the null function

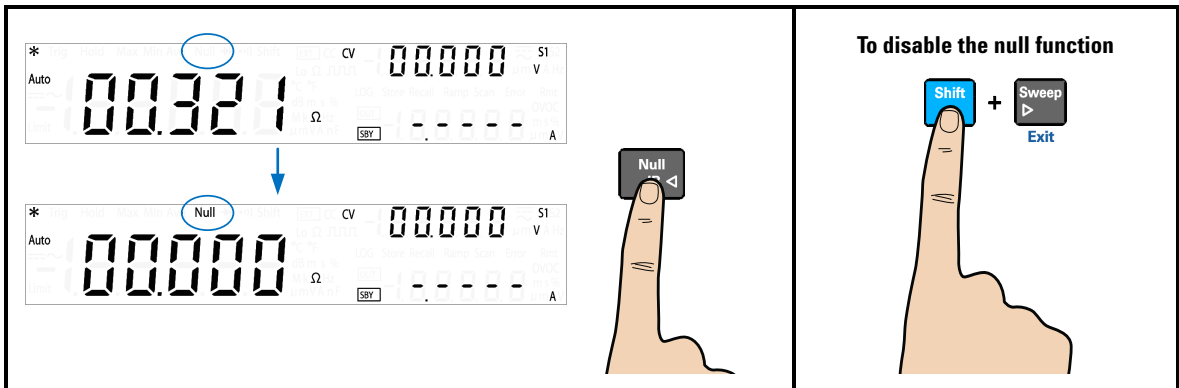

Edit the null value

1

2

Use the arrow keys to navigate the edit mode.

Utility

Null
dB ◀

Auto

▲

Range

▼

Save

Ramp Scan

▶

Sweep

▶

Exit

- Press [◀] or [▶] to select a digit position or range.
- Press [▲] or [▼] to increase or decrease the value selected.

3a

To save the changes

Shift

+

▼

Save

3b

To exit the edit mode without saving

Shift

+

▶

Exit

2 Operation and Features

Math Operations

dBm measurements

The logarithmic dBm (decibels relative to 1 mW) scale is often used in RF signal measurements. The U3606B takes a measurement and calculates the power delivered to a reference resistance (typically 50 Ω, 75 Ω, or 600 Ω). Voltage measurement is then converted to dBm.

NOTE

This math operation applies to voltage measurements only.

The dBm function is logarithmic, and is based on a calculation of power delivered to a reference resistance, relative to 1 mW. The formula used for calculating dBm measurements is:

$$dBm = 10 \times \log_{10}(\text{reading}^2 / (\text{reference resistance}) / (1 \text{ mW}))$$

You can select the reference resistance value through the Utility menu. The default setting is 600 Ω.

Enable the dBm function

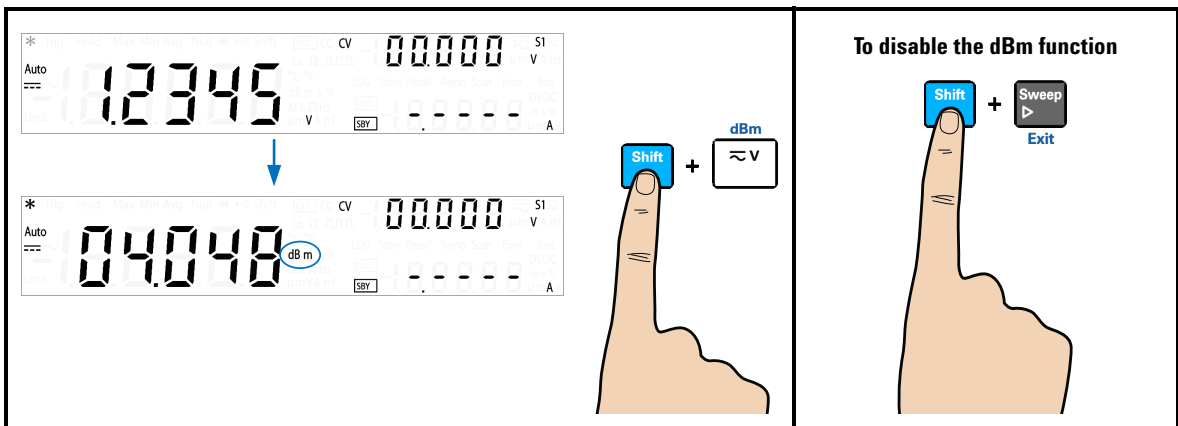

dB measurements

Each dB measurement is the difference between the input signal and a stored relative value, with both values converted to dBm. When enabled, the dB operation computes the dBm value for the next reading, stores the dBm result into the relative value register, and immediately produces the dB calculation. The formula used for calculating dB measurements is:

$$dB = \text{reading in dBm} - \text{relative value in dBm}$$

The *relative value* can take any value between 0 dBm and ± 120.000 dBm. The default relative value is 0 dBm. You can either let the instrument automatically measure this value, or you can enter a specific value.

NOTE

This math operation applies to voltage measurements only.

Enable the dB function

Enable the dBm function first.

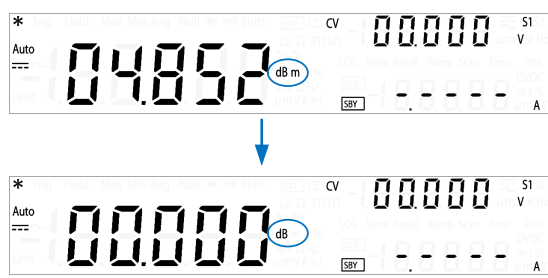

The first displayed reading is always precisely 00.000 dB.

To disable the dB function

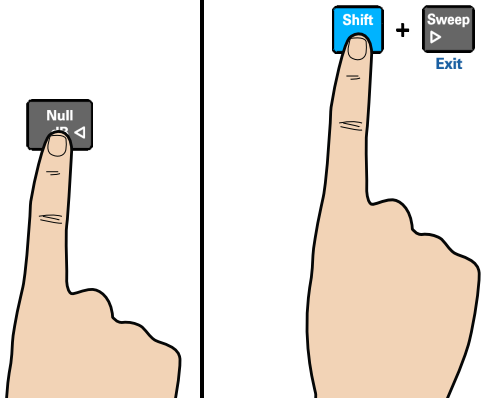

2 Operation and Features

Math Operations

Edit the relative value

1

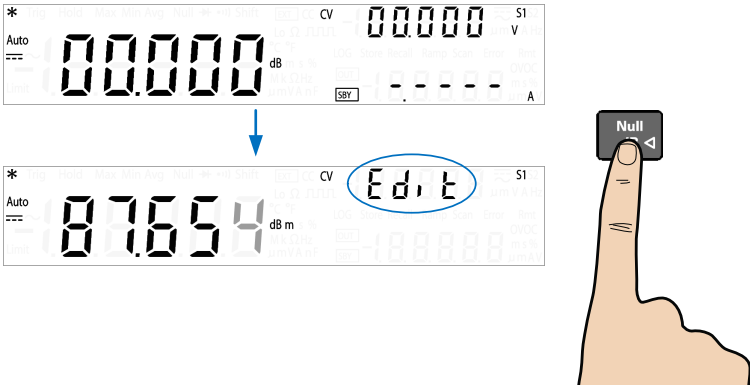

The diagram illustrates the process of entering edit mode. The top display shows a standard measurement of 000000 dB. A blue arrow points down to the bottom display, which shows the measurement 87654 dB m and the word 'Edit' circled in blue. A hand is shown pressing the 'Null' button.

2

Use the arrow keys to navigate the edit mode.

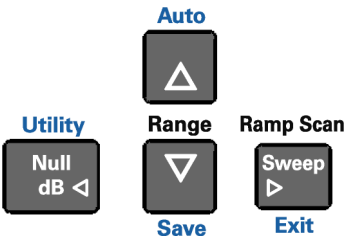

The diagram shows three groups of buttons: Utility (Null dB <), Range (Save), and Ramp Scan (Exit). The 'Null dB <' button is highlighted in blue.

- Press [<] or [>] to select a digit position or range.
- Press [Δ] or [∇] to increase or decrease the value selected.

3a

To save the changes

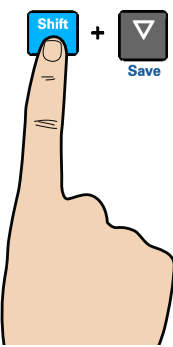

The diagram shows a hand pressing the 'Shift' button and the 'Save' button.

3b

To exit the edit mode without saving

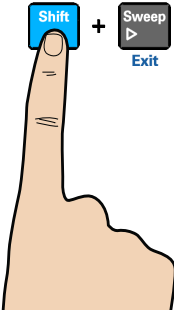

The diagram shows a hand pressing the 'Shift' button and the 'Exit' button.

MinMax

The MinMax operation stores the minimum and maximum values, the average, and the number of readings during a series of measurements. From the front panel, you can view the following statistical data for any set of readings: average or mean (Avg), maximum (Max), minimum (Min), or present reading (MaxMinAvg).

NOTE

- This math operation applies to all measurement functions except continuity and diode test.
- The stored statistical data are cleared when statistics are enabled, when the `CALCulate:FUNCTION` command is sent while the `CALCulate:STATE` is ON, when the power is turned off, after a Factory Reset (`*RST` command), after an Instrument Preset (`SYSTEM:PRESet` command), or after a measurement function change.
- The average function can be restarted by pressing **[MinMax]** for more than one second.

Enable the MinMax function

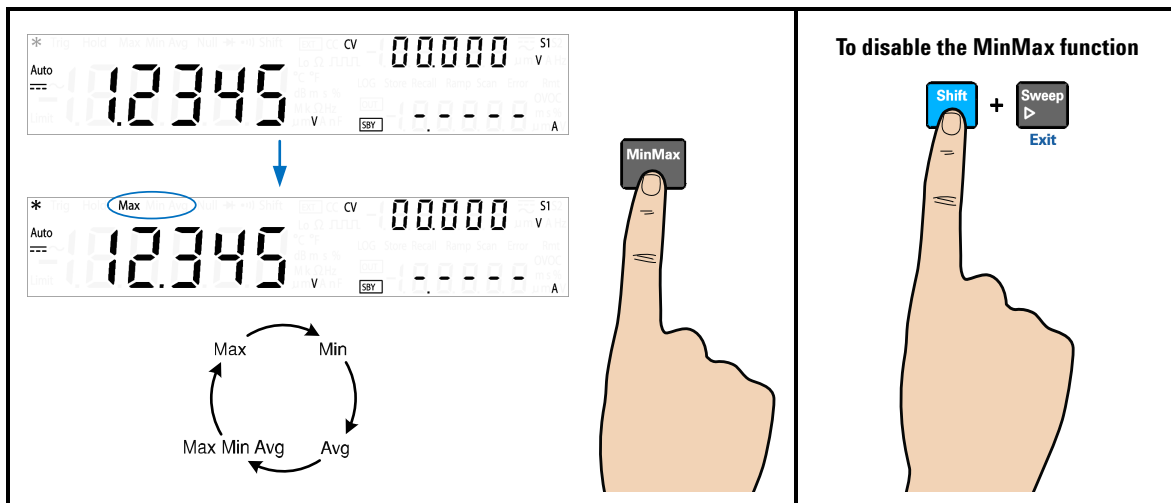

2 Operation and Features

Math Operations

NOTE

Each time a new minimum, maximum, or average value is stored, the instrument beeps once (if the beeper is enabled). The U3606B calculates the average of all readings and records the number of readings taken since the MinMax function was enabled.

Accumulated statistics are:

- Max: maximum reading since the MinMax function was enabled
 - Min: minimum reading since the MinMax function was enabled
 - Avg: average of all readings since the MinMax function was enabled
 - MaxMinAvg: present reading (actual input signal value)
-

Limit

The limit test function enables you to perform pass or fail testing to the upper and lower limits that you specify. You can set the upper and lower limits to any value between 0 and $\pm 120\%$ of the highest range for the present measurement function. The upper limit value you select must be larger than the lower limit value. The initial factory settings for both values is zero.

NOTE

- This math operation applies to all measurement functions except continuity and diode test.
 - The instrument clears all limits after a Factory Reset (*RST command), an Instrument Preset (SYSTEM:PRESet command), or when a measurement function is changed.
-

Enable the Limit function

The diagram illustrates the process of enabling and disabling the Limit function on a digital multimeter. On the left, the display shows '12345' and '00000'. A blue arrow points down to the same display showing 'PASS' and '00000', with the 'Limit' indicator circled in blue. A hand is shown pressing the 'Shift' button and the 'Limit/MinMax' button. On the right, the display shows 'PASS' and '00000'. A hand is shown pressing the 'Shift' button and the 'Sweep/Exit' button. The display then changes to 'Exit' and '00000'.

- **PASS:** Readings are within the specified limits.
- **HI:** Reading is above the high limit.
- **LO:** Reading is below the low limit.

NOTE

Each time the input value transitions from PASS to HI or from PASS to LO, or when transitioning directly from HI to LO or LO to HI, the U3606B beeps once (if the beeper is enabled).

2 Operation and Features

Math Operations

Edit the upper and lower limit values



Save the changes to edit the next limit.

1

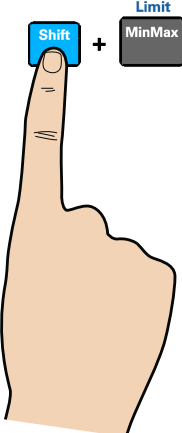

Use the arrow keys to navigate the edit mode.

Utility

Null
dB ◀

Auto

▲

Range

▼

Ramp Scan

Sweep
▶

Save

Exit

- Press [◀] or [▶] to select a digit position or range.
- Press [▲] or [▼] to increase or decrease the value selected.

To save the changes

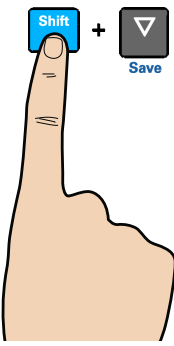

3a

To exit the edit mode without saving

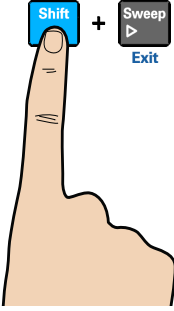

3b

Hold

The refresh hold feature allows you to capture and hold a reading, within the specified variation and threshold values, on the front panel display. This is useful in situations when you want to take a reading, remove the test probes, and have the reading remain on the display.

When a stable reading is detected, the instrument beeps once (if the beeper is enabled), and holds the reading on the primary display. You can select the variation through the Utility menu. The default setting is 10% of the full scale.

A new reading value is updated in the primary display when the variation of the measured value exceeds the variation preset in the Utility menu. The instrument beeps once (if the beeper is enabled) when a reading value is updated.

NOTE

- If the reading value is unable to reach a stable state (when exceeding the preset variation), the reading value will not be updated.
- For voltage, current, and capacitance measurements, the reading value will not be updated when the reading falls below the threshold preset in the Utility menu.
- For continuity and diode tests, the reading value will not be updated when an open state is detected.

Set the variation to “OFF” in the Utility menu to enable data hold. In data hold mode, the reading is not updated even if the input signal value changes. The reading held will remain on the display until you exit the hold mode.

2 Operation and Features

Math Operations

Enable the Hold function

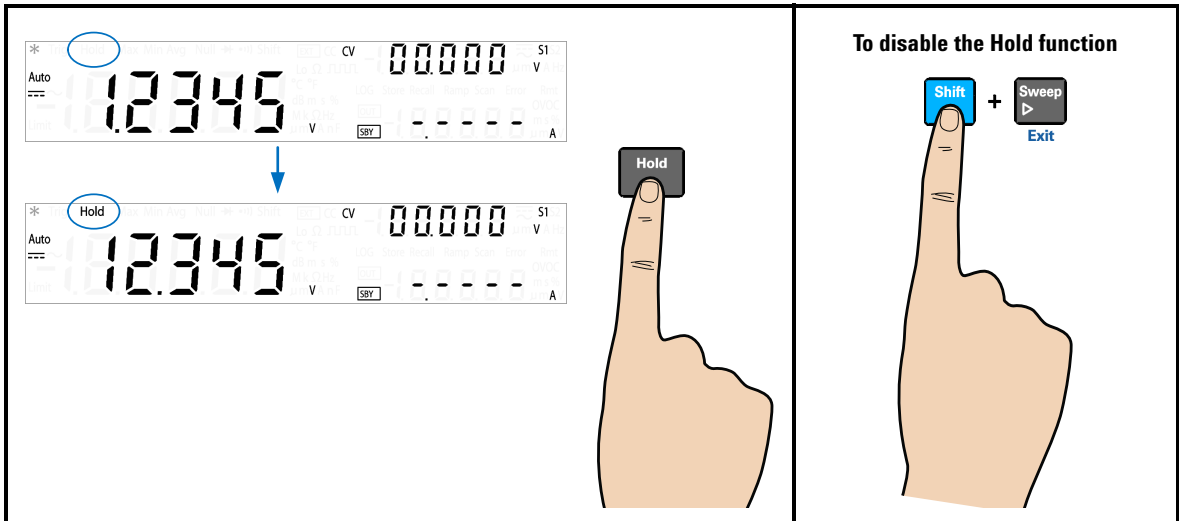

Triggering the Multimeter

The U3606B triggering system allows you to generate triggers either automatically or manually via the **[Trig]** key on the front panel or the *TRG command via the remote interface.

From the front panel (local interface), the multimeter always auto-triggers by default. Auto triggering takes continuous readings at the fastest rate possible for the selected measurement configuration.

You can enable the single trigger function to manually trigger the U3606B readings (see [page 76](#)).

From the remote interface, triggering the U3606B is a three-step process:

- 1** Configure the U3606B for measurement by selecting the function, range, resolution, and so on.
- 2** Specify the U3606B trigger source. The U3606B will accept a software (bus) command or an immediate (continuous) trigger.
- 3** Ensure that the U3606B is ready to accept a trigger from the specified source (called the “wait-for-trigger” state).

See [page 77](#) for more information on the software (bus) or immediate triggering source.

2 Operation and Features

Triggering the Multimeter

Front panel triggering

Single triggering

The U3606B takes one reading each time you press **[Trig]**.

NOTE

The single trigger mode is available from the local interface only.

Enable the single trigger function

The diagram is divided into three numbered sections:

- 1**: Shows the multimeter display in 'Auto' mode with a reading of 12345. A blue circle highlights the 'Trig' button. A blue arrow points to the next step. A hand is shown pressing the 'Shift' button (highlighted in blue) and the 'Trig Hold' button (highlighted in grey).
- 2**: Shows the multimeter display in 'Trig' mode with a reading of 12345. A blue circle highlights the 'Trig' button. A blue arrow points to the next step. A hand is shown pressing the 'Trig Hold' button (highlighted in grey).
- 3**: Shows the multimeter display in 'Auto' mode with a reading of 12300. A blue circle highlights the 'Trig' button. A hand is shown pressing the 'Shift' button (highlighted in blue) and the 'Trig Hold' button (highlighted in grey).

To disable the Trig function

Press **[Trig]** again to capture another reading.
Note that you do not need to press **[Shift]** again.

Remote interface triggering

Immediate triggering

In the immediate trigger mode, the trigger signal is always present. When you place the multimeter in the wait-for-trigger state, the trigger is issued immediately. This is the default trigger source for the U3606B.

NOTE

The immediate trigger mode is available from the remote interface only.

Remote interface operation:

- The `TRIGger:SOURce IMMEDIATE` command selects the immediate trigger source.
- After selecting the trigger source, you must place the instrument in the “wait-for-trigger” state using the `INITiate[:IMMEDIATE]` or `READ?` command. A trigger will not be accepted from the selected trigger source until the instrument is in the “wait-for-trigger” state.

Refer to the *U3606B Programmer's Reference* for the syntax and complete descriptions for these commands.

Software (bus) triggering

The bus trigger mode corresponds in function as the **Single triggering** mode, except the trigger is initiated by sending a bus trigger command, after selecting `BUS` as the trigger source.

NOTE

The bus trigger mode is available from the remote interface only.

2 Operation and Features

Triggering the Multimeter

Remote interface operation:

- The `TRIGger:SOURce BUS` command selects the bus trigger source.
- The `MEASure?` command overwrites the bus trigger and triggers the U3606B and returns a measurement.
- The `READ?` command does not overwrite the bus trigger, and if selected, generates an error. It will only trigger the instrument and return a measurement when the `IMMEdiate` trigger is selected.
- The `INITiate` command only initiates the measurement and needs a trigger (`*TRG` command) to make the actual measurement.

Refer to the *U3606B Programmer's Reference* for the syntax and complete descriptions for these commands.

3

DC Power Supply Operation

Constant Voltage Operation	80
Constant Current Operation	83
Protection Functions	86
Over-voltage protection (OVP)	86
Over-current protection (OCP)	90
Over-voltage limit (OV)	94
Over-current limit (OC)	97
Square-Wave Operation	100
Sweep Functions	106
Ramp signal	106
Scan signal	109
Selecting a Range	113
Enabling the Output	114
Remote Sensing	115

This chapter contains examples on how to operate the DC power supply from the front panel.

3 DC Power Supply Operation Constant Voltage Operation

Constant Voltage Operation

Connect the load

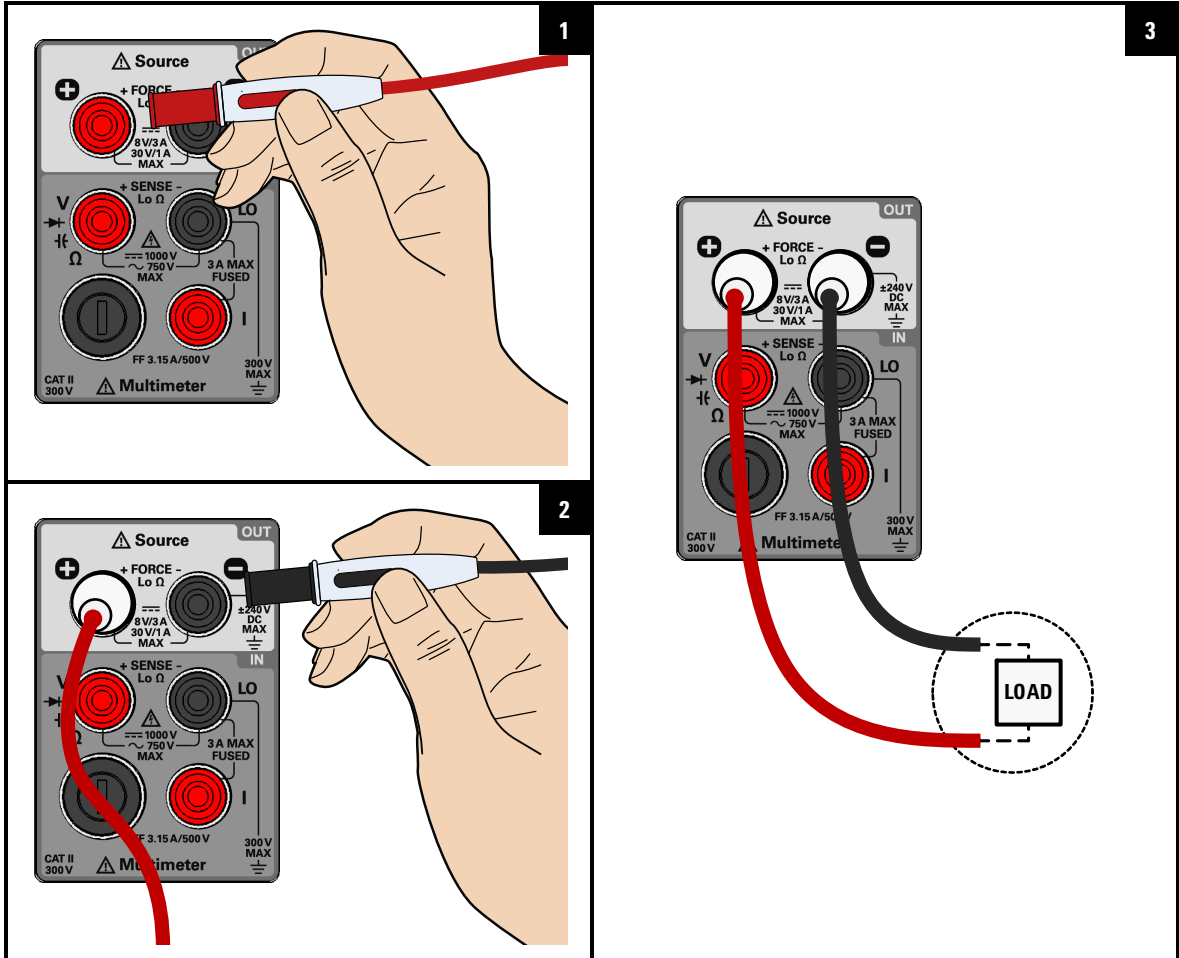

Select the constant voltage function

4

5

The CV annunciator will turn on according to your selection.

Adjust the constant voltage value

6

Use the arrow keys to change the value.

- Press [◀] or [▶] to select a digit position or range.
- Press [▲] or [▼] to increase or decrease the value selected.

Note: If the CV annunciator is not flashing, press **[Voltage]** again. The output voltage can be programmed when the output is enabled (OUT) or disabled (SBY).

7

To exit the edit mode

3 DC Power Supply Operation

Constant Voltage Operation

Enable the output

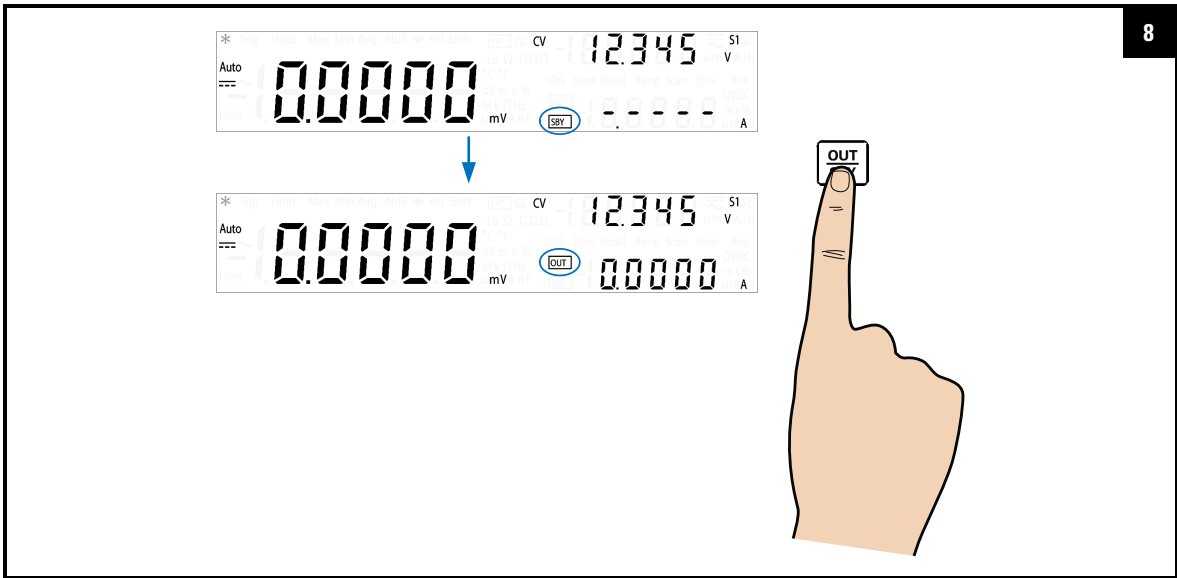

NOTE

- The output voltage is limited by the range selected. Press **[Shift] > [Range]** to select an appropriate range. You can only select a range when the output is disabled (the SBY annunciator is illuminated).
- While adjusting the constant voltage value, you can also press **[Voltage]** again or **[Shift] > [Exit]** to exit the edit mode.

Constant Current Operation

Connect the load

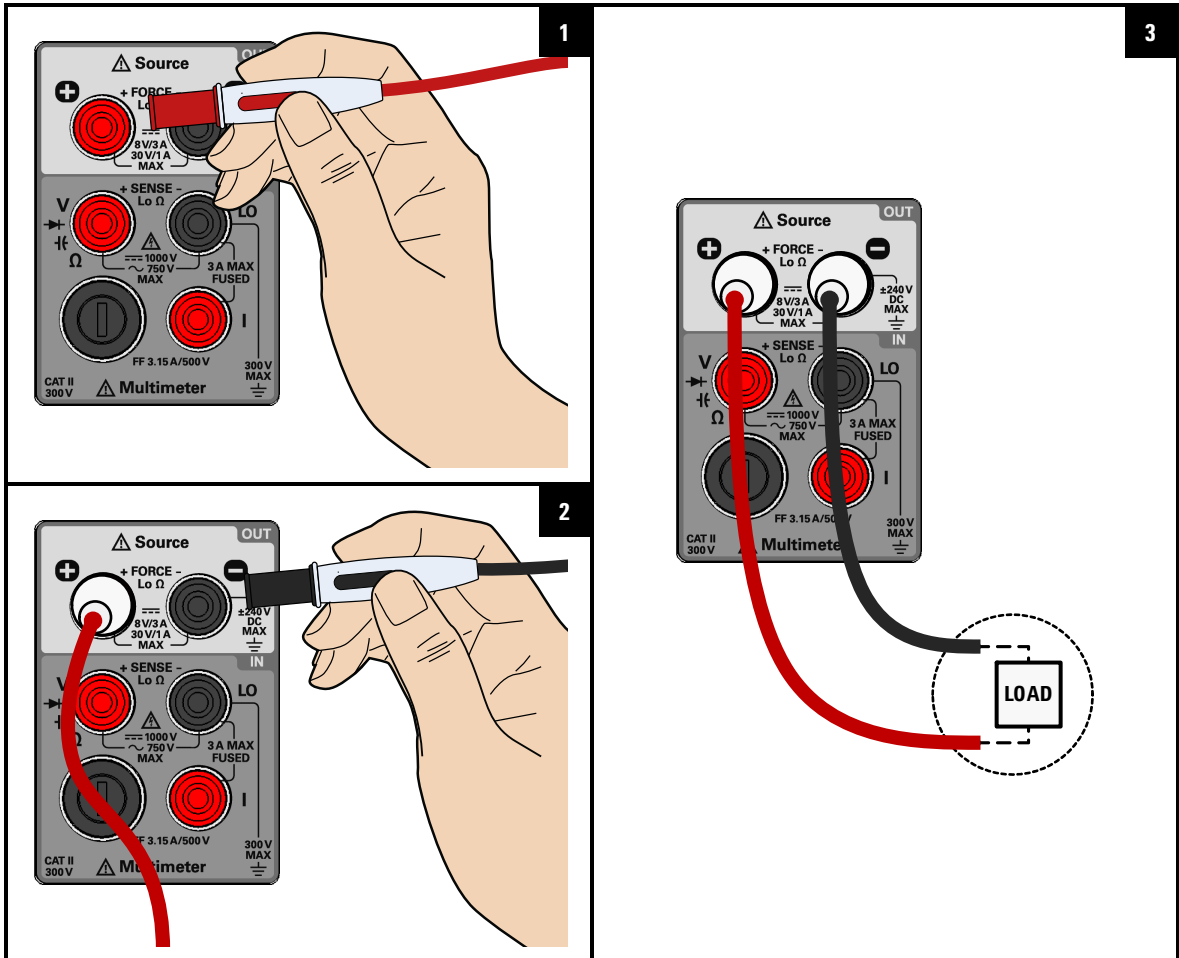

3 DC Power Supply Operation

Constant Current Operation

Select the constant current function

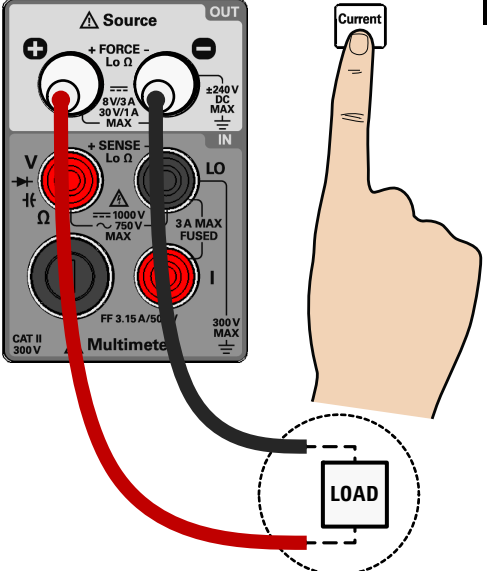

4



5

The CC annunciator will turn on according to your selection.

Adjust the constant current value

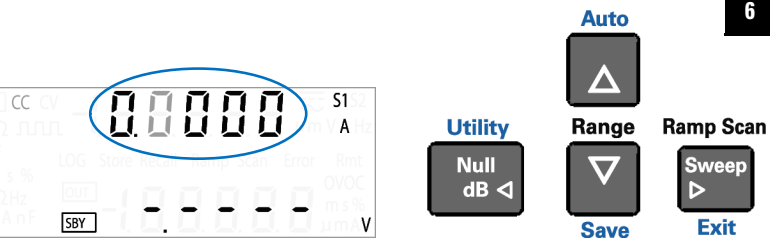

6

To exit the edit mode

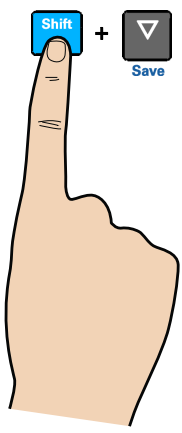

7

Use the arrow keys to change the value.

- Press [◀] or [▶] to select a digit position or range.
- Press [▲] or [▼] to increase or decrease the value selected.

Note: If the CC annunciator is not flashing, press [Current] again. The output current can be programmed when the output is enabled (OUT) or disabled (SBY).

Enable the output

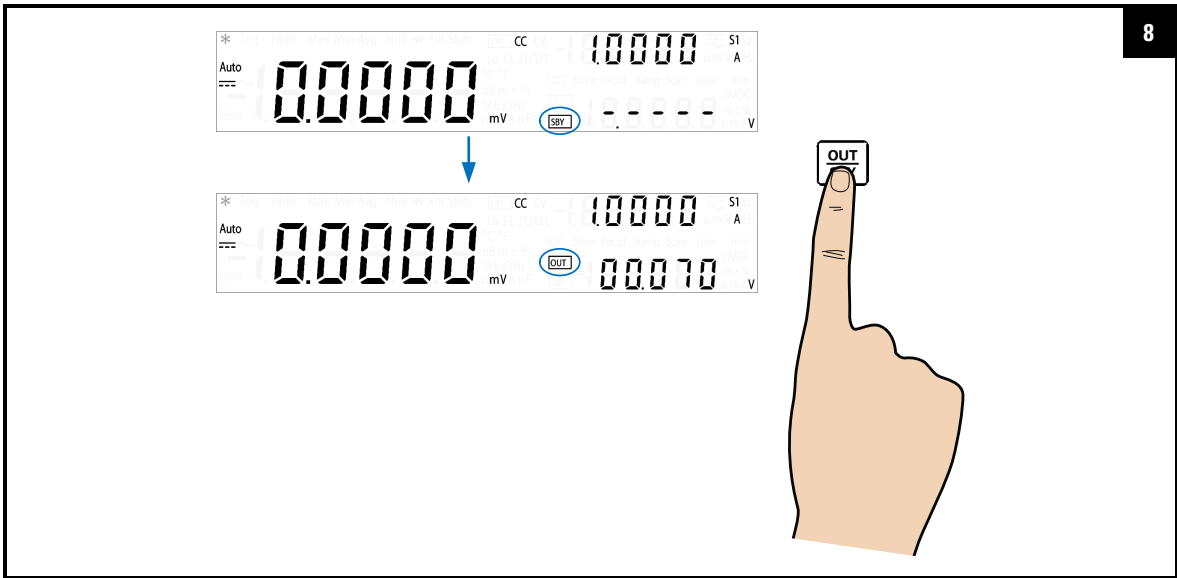

NOTE

- The output current is limited by the range selected. Press **[Shift]** > **[Range]** to select an appropriate range. You can only select a range when the output is disabled (the SBY annunciator is illuminated).
- While adjusting the constant current value, you can also press **[Current]** again or **[Shift]** > **[Exit]** to exit the edit mode.

Protection Functions

Over-voltage protection (OVP)

In constant current mode, the U3606B regulates the output current at the selected value, while the voltage varies as required by the load. The over-voltage protection protects against over-voltage conditions on the output. If the load attempts to draw more voltage than required, such that it exceeds the programmed protection value, the over-voltage protection circuit will protect the load by disabling the output.

The following steps shows you how to set the OVP trip level, how to check OVP operation, and how to clear the OVP condition.

NOTE

Setting the OVP trip level will not activate the OVP feature. To activate the OVP feature, you will need to enable the output protection state from the Utility menu.

Select the constant current function

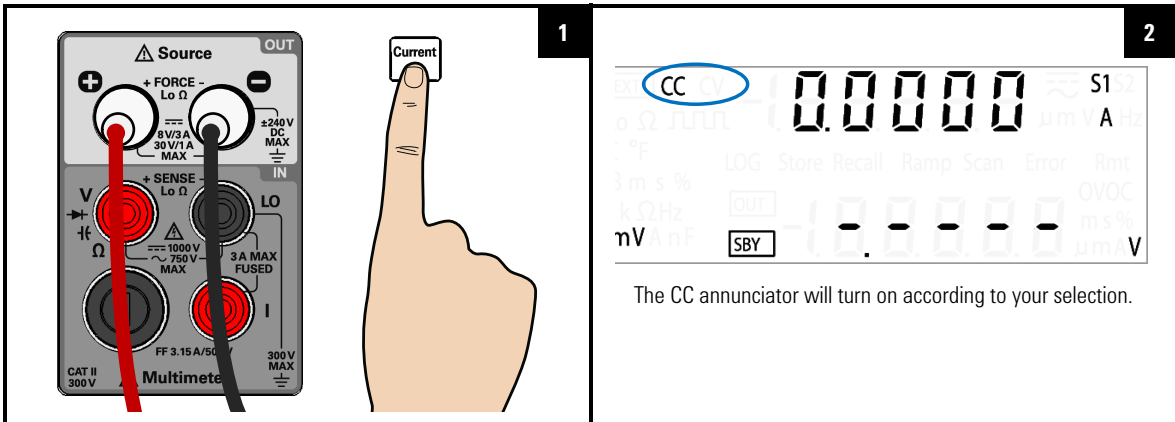

The diagram is divided into two numbered sections:

- 1**: Shows a close-up of a multimeter's input terminals. A red probe is inserted into the 'FORCE' terminal (marked with a plus sign and 'Lo Ω'). A black probe is inserted into the 'SENSE' terminal (marked with a minus sign and 'Lo Ω'). A hand is shown pointing to a label that says 'Current'.
- 2**: Shows the digital display of the U3606B power supply. The display shows '0.0000' with 'CC' circled in blue above it. Other indicators include 'S1', 'A', 'nV', and 'SBY'. Below the display, the text reads: 'The CC annunciator will turn on according to your selection.'

Select the OVP function

3

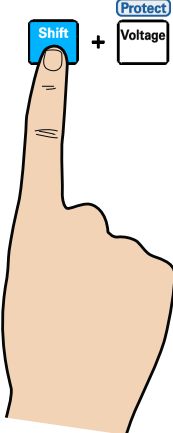

4



The OVP annunciator will turn on according to your selection.

Adjust the OVP value and save the changes

5

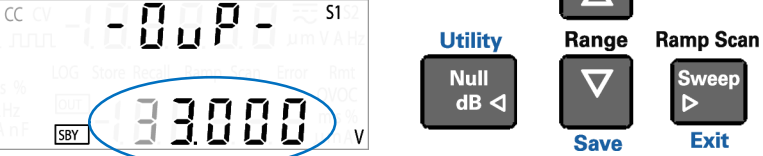

Use the arrow keys to change the value.

- Press [◀] or [▶] to select a digit position or range.
- Press [▲] or [▼] to increase or decrease the value selected.

Note: The OVP value is set to the maximum protection limits by default.

6

To save the changes

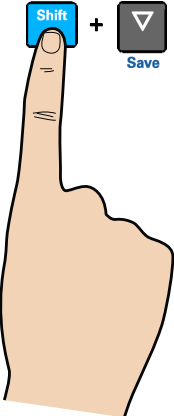

You can recall the OVP value set when you select "LAST" in the **P-on** Utility menu item (page 145).

3 DC Power Supply Operation

Protection Functions

NOTE

- After adjusting the OVP value, you can also press **[Protect]** again to save the changes made or press **[Shift] > [Exit]** to discard the changes made.
- The OVP feature is always enabled by default whenever you select constant current mode. You can disable the OVP feature by disabling the output protection state from the Utility menu.
- If the OVP value is set to a lesser value than the OV value, the OV value will be adjusted to equal the OVP value.
- The OVP value is not applicable for square-wave output.
- The OVP value is limited by the range selected. Press **[Shift] > [Range]** to select an appropriate range. You can only select a range when the output is disabled (the SBY annunciator is illuminated).

Table 3-1 CC mode over-voltage protection range and values

Range	Over-voltage protection value	
	Minimum	Maximum
S1 (30 V/1 A)	0 V	33 V
S1m (30 V/100 mA)	0 V	33 V
S2 (8 V/3 A)	0 V	8.8 V
S1S2 (autoranging)	N/A ^[1]	

[1] If the S1S2 (autoranging) range is selected, you will not be able to adjust the OVP value.

Checking the OVP operation

To check OVP operation, raise the regulated output current slowly. Watch the voltage drawn by the load as it reaches near the trip point. Then very gradually increase the output current using the arrow keys until the OVP circuit trips.

This will disable the U3606B output, cause the CC annunciator to flash, and the OV and Error annunciator to illuminate.

The “triP” message appears on the display after a few seconds of inactivity.



NOTE

Error number 510, “Voltage output over protection” will be recorded in the error queue when the OVP circuit trips. Enter the Utility menu to read and clear the error message.

Resetting the OVP condition

Use one of the following methods to reset the OVP circuit after it activates. If the condition that caused the over-voltage shutdown is still present, the OVP circuit will turn the output off again.

- When the OVP circuit trips, the U3606B will immediately prompt you to change the OVP trip level. Use the arrow keys to select a higher OVP trip level and press **[Shift]** > **[Save]** or **[Protect]** to save the changes.
- Alternatively, press **[Shift]** > **[Exit]** to exit the edit mode without changing the OVP trip level.
- You may read and clear the error message by accessing the Utility menu.

If the OVP continues to trip, try lowering the regulated output current, or raising the OVP trip level.

3 DC Power Supply Operation

Protection Functions

Over-current protection (OCP)

In constant voltage mode, the U3606B regulates the output voltage at the selected value, while the load current varies as required by the load. The over-current protection will disable the output if the load effect exceeds the programmed protection value. This protection is useful when the load is sensitive to an over-current condition.

The following steps shows you how to set the OCP trip level, how to check OCP operation, and how to clear the OCP condition.

NOTE

Setting the OCP trip level will not activate the OCP feature. To activate the OCP feature, you will need to enable the output protection state from the Utility menu.

Select the constant voltage function

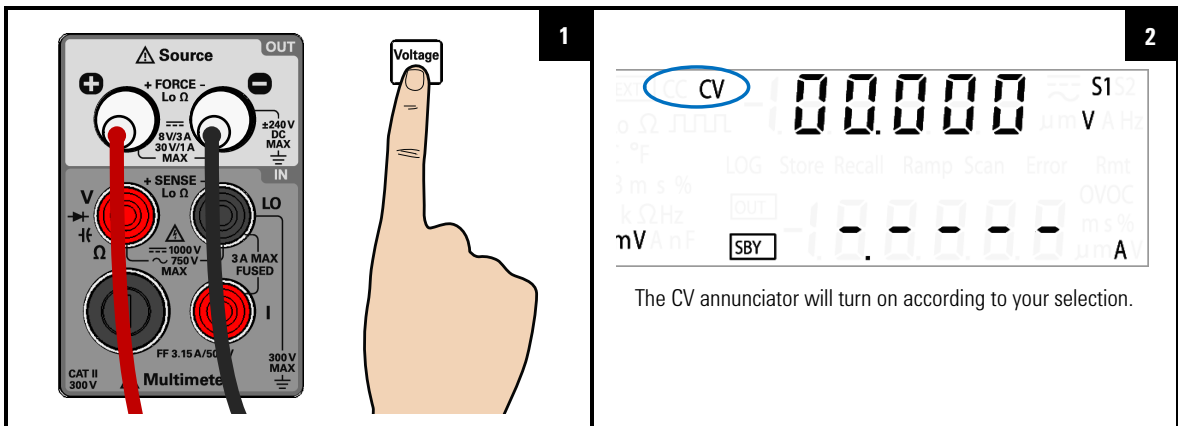

Select the OCP function

3

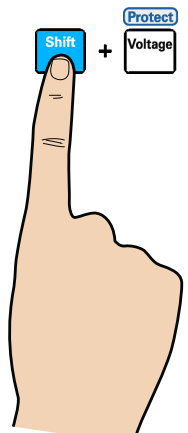

4



The OVP annunciator will turn on according to your selection.

Adjust the OCP value and save the changes

5

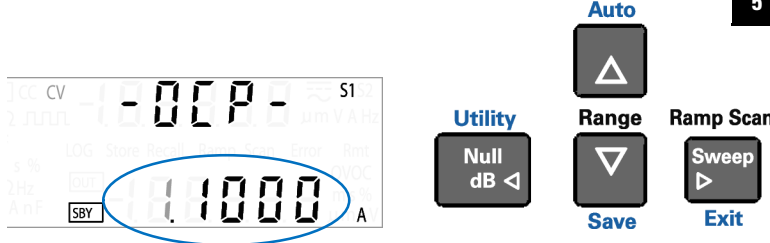

Use the arrow keys to change the value.

- Press [<] or [>] to select a digit position or range.
- Press [Δ] or [▽] to increase or decrease the value selected.

Note: The OCP value is set to the maximum protection limits by default.

6

To save the changes

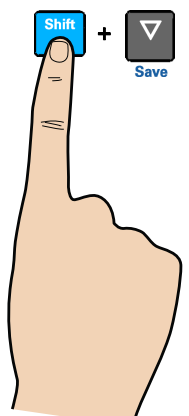

You can recall the OCP value set when you select "LAST" in the **P-on** Utility menu item (page 145).

3 DC Power Supply Operation

Protection Functions

NOTE

- After adjusting the OCP value, you can also press **[Protect]** again to save the changes made or press **[Shift] > [Exit]** to discard the changes made.
- The OCP feature is always enabled by default whenever you select constant current mode. You can disable the OCP feature by disabling the output protection state from the Utility menu.
- If the OCP value is set to a lesser value than the OC value, the OC value will be adjusted to equal the OCP value.
- The OCP value is not applicable for square-wave output.
- The OCP value is limited by the range selected. Press **[Shift] > [Range]** to select an appropriate range. You can only select a range when the output is disabled (the SBY annunciator is illuminated).

Table 3-2 CV mode over-current protection range and values

Range	Over-current protection value	
	Minimum	Maximum
S1 (30 V/1 A)	0 A	1.1 A
S2 (8 V/3 A)	0 A	3.3 A
S2m (1000 mV/3 A)	0 A	3.3 A
S1S2 (autoranging)	N/A ^[1]	

[1] If the S1S2 (autoranging) range is selected, you will not be able to adjust the OCP value.

Checking the OCP operation

To check OCP operation, raise the regulated output current slowly. Watch the voltage drawn by the load as it reaches near the trip point. Then very gradually increase the output current using the arrow keys until the OCP circuit trips.

This will disable the U3606B output, cause the CC annunciator to flash, and the OC and Error annunciator to illuminate.

The “triP” message appears on the display after a few seconds of inactivity.



NOTE

Error number 511, “Current output over protection” will be recorded in the error queue when the OCP circuit trips. Enter the Utility menu to read and clear the error message.

Resetting the OCP condition

Use one of the following methods to reset the OCP circuit after it activates. If the condition that caused the over-current shutdown is still present, the OCP circuit will turn the output off again.

- When the OCP circuit trips, the U3606B will immediately prompt you to change the OCP trip level. Use the arrow keys to select a higher OCP trip level and press **[Shift]** > **[Save]** or **[Protect]** to save the changes.
- Alternatively, press **[Shift]** > **[Exit]** to exit the edit mode without changing the OCP trip level.
- You may read and clear the error message by accessing the Utility menu.

If the OCP continues to trip, try lowering the regulated output current, or raising the OCP trip level.

NOTE

To protect itself, the U3606B will trip when a large current (over the system protection values) is detected, even if the triP option (page 140) is disabled in the Utility menu.

3 DC Power Supply Operation

Protection Functions

Over-voltage limit (OV)

The over-voltage limit prevents the output voltage present across the load to change beyond the programmed over-voltage limit. If the load effect exceeds the programmed over-voltage limit, the CC output will be lowered to maintain the output power across the load. The combination of the OV and OVP features create a closed loop circuit protection for sensitive load behaviors.

Select the constant current function

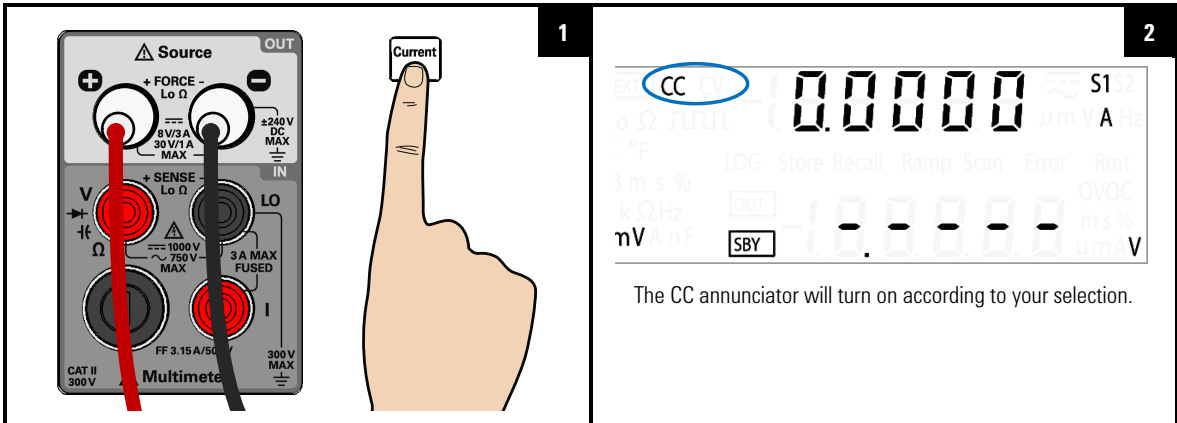

1

2

CC

0.0000

S1

A

LOG Store Recall Ramp Scan Error Rmt

OUT

SBY

nV

The CC annunciator will turn on according to your selection.

Select the OV function

3

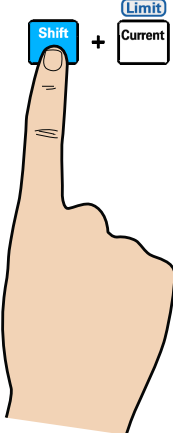

4



The OV annunciator will turn on according to your selection.

Adjust the OV value and save the changes

5

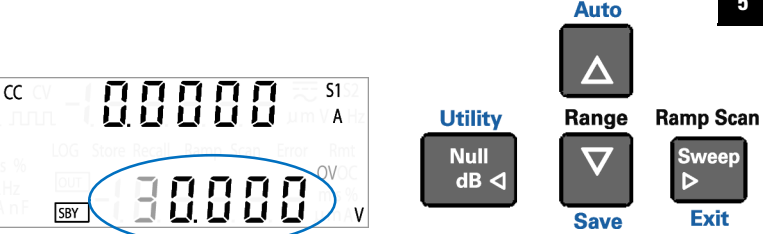

Use the arrow keys to change the value.

- Press [◀] or [▶] to select a digit position or range.
- Press [▲] or [▼] to increase or decrease the value selected.

Note: The OV value is set to the maximum protection limits by default.

6

To save the changes

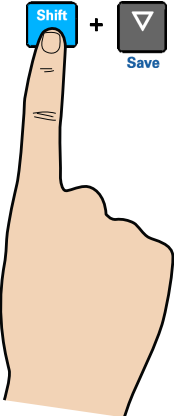

You can recall the OV value set when you select "LAST" in the **P-on** Utility menu item (page 145).

3 DC Power Supply Operation

Protection Functions

NOTE

- After adjusting the OV value, you can also press **[Limit]** again to save the changes made or press **[Shift] > [Exit]** to discard the changes made.
- The OV feature is always enabled by default whenever you select constant current mode. You cannot disable the OV feature.
- If the OV value is set to a greater value than the OVP value, the OVP value will be adjusted to equal the OV value.
- If the OV value is set to zero, this will result in the output current being dropped to zero for limiting.
- The OV value is not applicable for square-wave output.
- The OV value is limited by the range selected. Press **[Shift] > [Range]** to select an appropriate range. You can only select a range when the output is disabled (the SBY annunciator is illuminated).

Table 3-3 CC mode over-voltage range and values

Range	Over-voltage value	
	Minimum	Maximum
S1 (30 V/1 A)	0 V	31.5 V
S1m (30 V/100 mA)	0 V	31.5 V
S2 (8 V/3 A)	0 V	8.4 V
S1S2 (autoranging)	N/A ^[1]	

[1] If the S1S2 (autoranging) range is selected, you will not be able to adjust the OV value.

Over-current limit (OC)

The over-current limit prevents the output current flowing through the load to change beyond the programmed over-current limit. If the load effect exceeds the programmed over-current limit, the CV output will be lowered to maintain the output power across the load. The combination of the OC and OCP features create a closed loop circuit protection for sensitive load behaviors.

Select the constant current function

1

2

The CV annunciator will turn on according to your selection.

3 DC Power Supply Operation

Protection Functions

Select the OC function

3



4

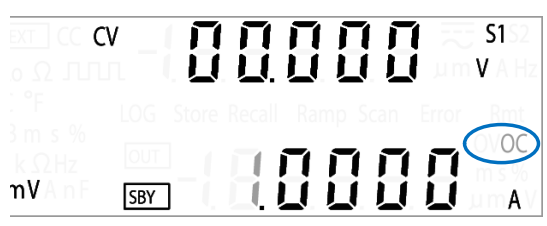

The OC annunciator will turn on according to your selection.

Adjust the OC value and save the changes

5

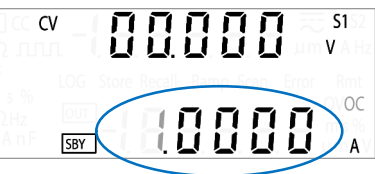

Use the arrow keys to change the value.

- Press [◀] or [▶] to select a digit position or range.
- Press [▲] or [▼] to increase or decrease the value selected.

Note: The OC value is set to the maximum protection limits by default.

6

To save the changes

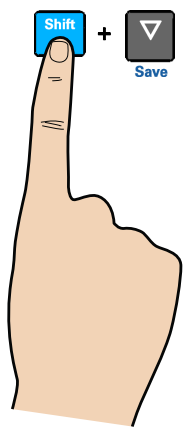

You can recall the OC value set when you select "LAST" in the **P-on** Utility menu item (page 145).

Utility

Null
dB ◀

Auto

▲

Range

▼

Save

Ramp Scan

▶

Sweep

Exit

NOTE

- After adjusting the OC value, you can also press **[Limit]** again to save the changes made or press **[Shift] > [Exit]** to discard the changes made.
- The OC feature is always enabled by default whenever you select constant current mode. You cannot disable the OC feature.
- If the OC value is set to a greater value than the OCP value, the OCP value will be adjusted to equal the OC value.
- If the OC value is set to zero, this will result in the output voltage being dropped to zero for limiting.
- The OC value is not applicable for square-wave output.
- The OC value is limited by the range selected. Press **[Shift] > [Range]** to select an appropriate range. You can only select a range when the output is disabled (the SBY annunciator is illuminated).

Table 3-4 CV mode over-current range and values

Range	Over-current value	
	Minimum	Maximum
S1 (30 V/1 A)	0 A	1.05 A
S2 (8 V/3 A)	0 A	3.15 A
S2m (1000 mV/3 A)	0 A	3.15 A
S1S2 (autoranging)	N/A ^[1]	

[1] If the S1S2 (autoranging) range is selected, you will not be able to adjust the OC value.

3 DC Power Supply Operation

Square-Wave Operation

Square-Wave Operation

The square-wave function is a unique function for many applications, such as pulse width modulation (PWM) output, adjustable voltage control, and synchronous clock (baud rate generator). You can also use this function to check and calibrate flow-meter displays, counters, tachometers, oscilloscopes, frequency converter, frequency transmitter, and other frequency input devices.

Connect the load

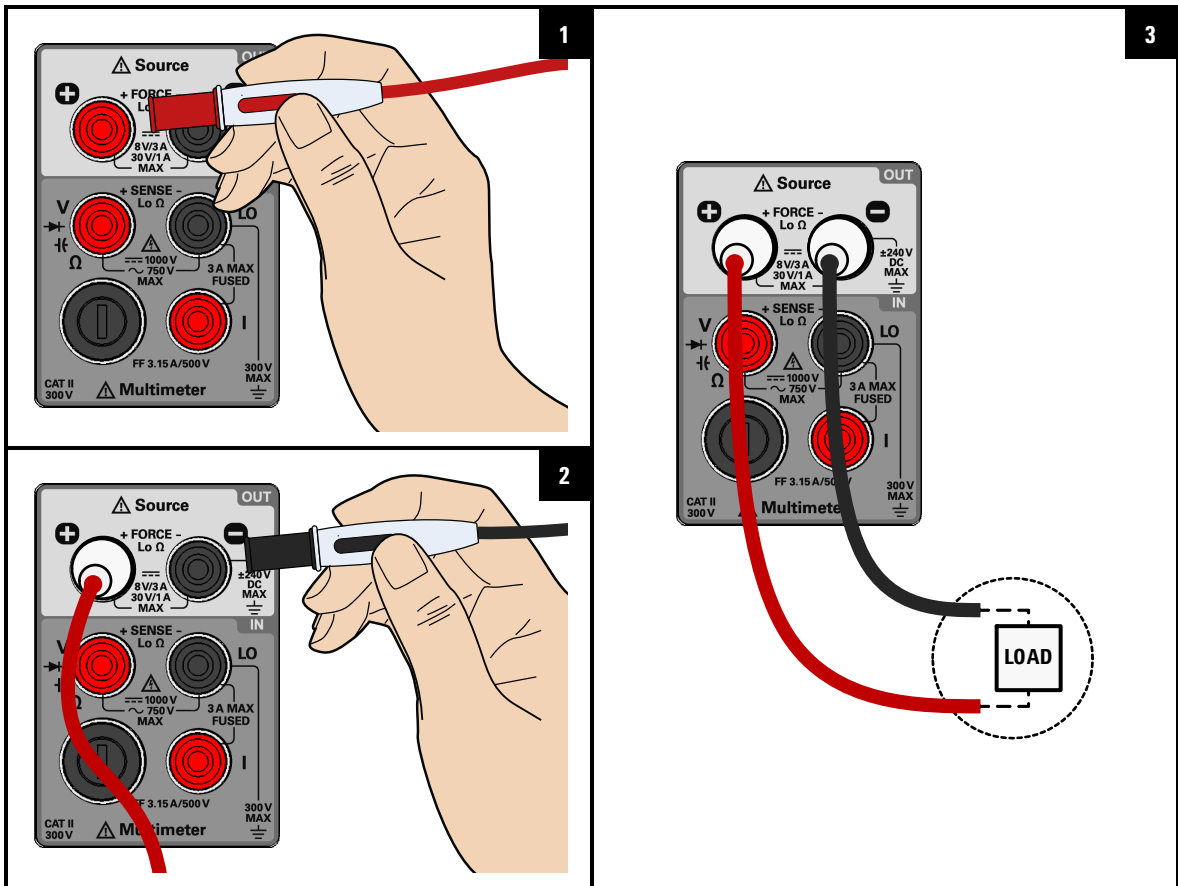

Select the square wave function

4

5

The annunciator will turn on according to your selection.

View the amplitude, duty cycle, and pulse width values

6

Press [] again to cycle between amplitude, duty cycle, or pulse width values.

3 DC Power Supply Operation

Square-Wave Operation

Enable the output

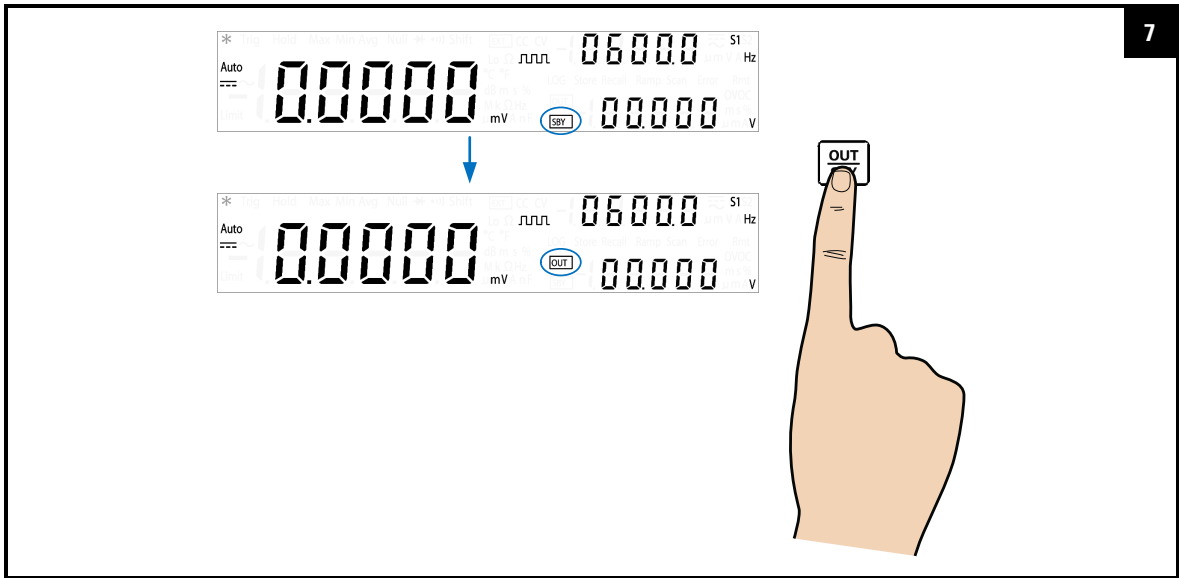

Adjust the amplitude, duty cycle, and pulse width values

Press [] again to cycle between amplitude, duty cycle, or pulse width values.

1

Adjust the amplitude value and save the changes

Use the arrow keys to change the value.

- Press [] or [] to select a digit position or range.
- Press [] or [] to increase or decrease the value selected.

Note: If the annunciator is not flashing, press [] again.

Utility

Auto

Range

Save

Ramp Scan

Exit

To exit the edit mode

+

Save

2

3

3 DC Power Supply Operation

Square-Wave Operation

Adjust the frequency, duty cycle, or pulse width values and save the changes

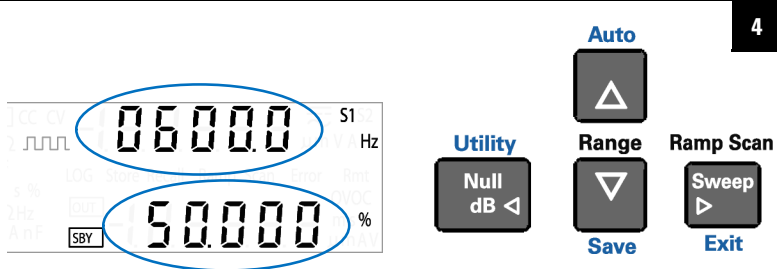

Use the arrow keys to change the value.

- Press [◀] or [▶] to step through the available frequencies.
- Press [▲] or [▼] to step through the available duty cycle (or pulse width) values.

Note: To adjust the frequency value, the duty cycle or pulse width values must be shown on the display.

4

To exit the edit mode

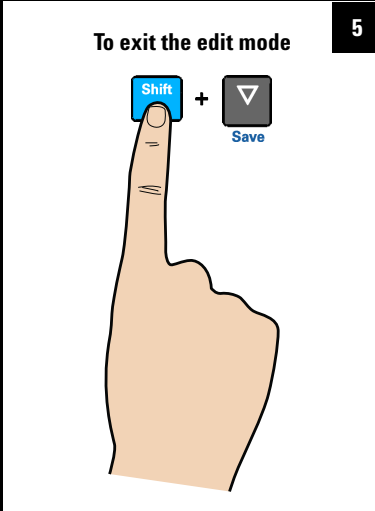

5

NOTE

- Pressing [] again will save the changes, and display the next square-wave parameter. (While still in the edit mode.)
- While adjusting the amplitude, duty cycle, and pulse width values you can also press [Shift] > [Exit] to exit the edit mode.
- The square-wave amplitude is limited by the range selected. Press [Shift] > [Range] to select an appropriate range. You can only select a range when the output is disabled (the SBY annunciator is illuminated).
- Changing the square-wave frequency value will affect the square-wave duty cycle and pulse width values as they are inter-related.

Table 3-5 Square-wave amplitude minimum and maximum values

Range	Square wave amplitude value	
	Minimum	Maximum
S1 (30 V/1 A)	0 V	30 V
S2 (8 V/3 A)	0 V	8 V
S1S2 (autoranging)	0 V	30 V

NOTE

- The frequency can be stepped through multiple steps from 0.5 Hz, 2 Hz, 5 Hz, ..., 4800 Hz (or 10 Hz to 4800 Hz if range S1S2 (autoranging) is selected).
- If range S1S2 (autoranging) is selected, the duty cycle is fixed at 50%.
- The duty cycle can be stepped through 256 steps, where each step is 0.390625% more than the previous step. The best resolution the display can offer is 0.001%.
- The pulse width can be stepped through 256 steps, where each step is $1/(256 \times \text{frequency})$ more than the previous step. The display will automatically adjust to a 5 digit resolution (ranging from 9.9999 ms to 999.99 ms)

Sweep Functions

The U3606B is equipped with ramp and scan capability. Use the ramp function to generate a ramp signal with its end amplitude position and number of steps based on the preset input parameters and the scan function to generate a scan signal with its end amplitude position, step dwelling time, and number of steps based on the preset input parameters.

Ramp signal

A typical ramp signal length is based on the following parameters:

- the amplitude end position, and
- the number of steps required to reach the amplitude end position.

You can configure the ramp signal amplitude end position and number of steps in the Utility menu.

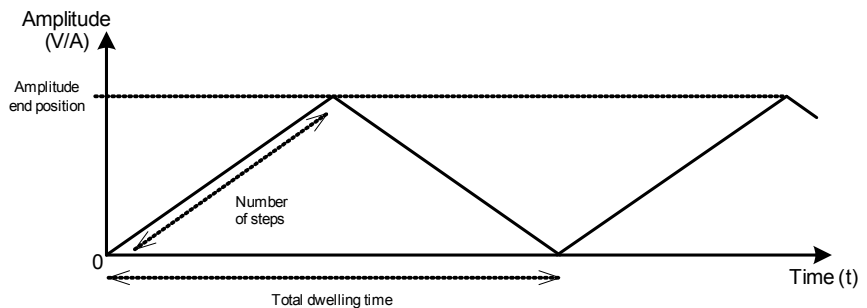

The ramp dwelling time will be set to the fastest of the instrument capability (typically ~100 ms per step). A higher number of steps provides a more linear ramp signal. This however will result in an increase in the total dwelling time. A lower number of steps will result in a shorter total dwelling time and a more stepped ramp signal.

Connect the load

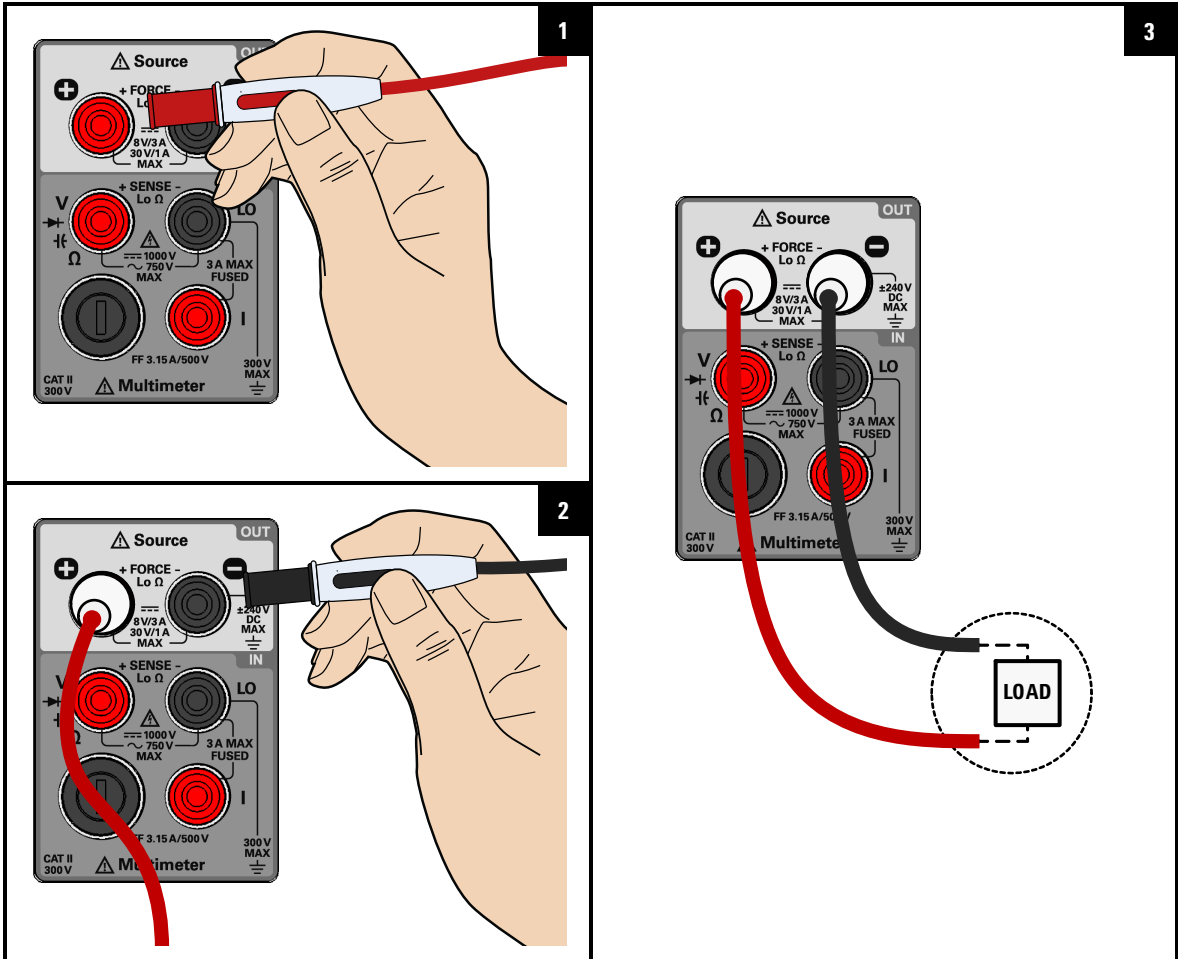

3 DC Power Supply Operation

Sweep Functions

Select the constant voltage or constant current function

4

5

The CV or CC annunciator will turn on according to your selection.

Select the ramp function and enable the output

6

Press **[Sweep]** to switch the between ramp and scan functions.

The Ramp annunciator will turn on according to your selection.

7

NOTE

- The typical ramp dwelling time per step in the U3606B is measured at 100 ms. A longer delay time should be expected if a high number of steps is programmed. As an example, a 1000 step ramp signal will yield a 200 seconds ($1000 \times 100 \text{ ms} \times 2$) total dwelling time.
- If you want to adjust the ramp signal parameters, press [**Shift**] > [**Utility**] to access the Utility menu.
- The maximum amplitude end position will be limited by the range and function (CV or CC) selected.

Scan signal

A typical scan signal length is based on the following parameters:

- the amplitude end position,
- the number of steps required to reach the amplitude end position, and
- the dwelling time length for each step.

You can configure the scan signal amplitude end position, number of steps, and dwelling time length in the Utility menu.

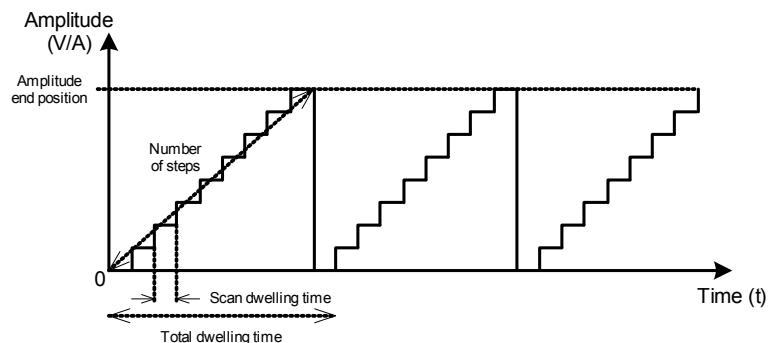

3 DC Power Supply Operation

Sweep Functions

The total dwell time will increase with respect to the number of steps and the scan dwell time per step selected. The scan dwell time is defined as the length of time the scan signal will “dwell” in the present step before incrementing to the next step.

Connect the load

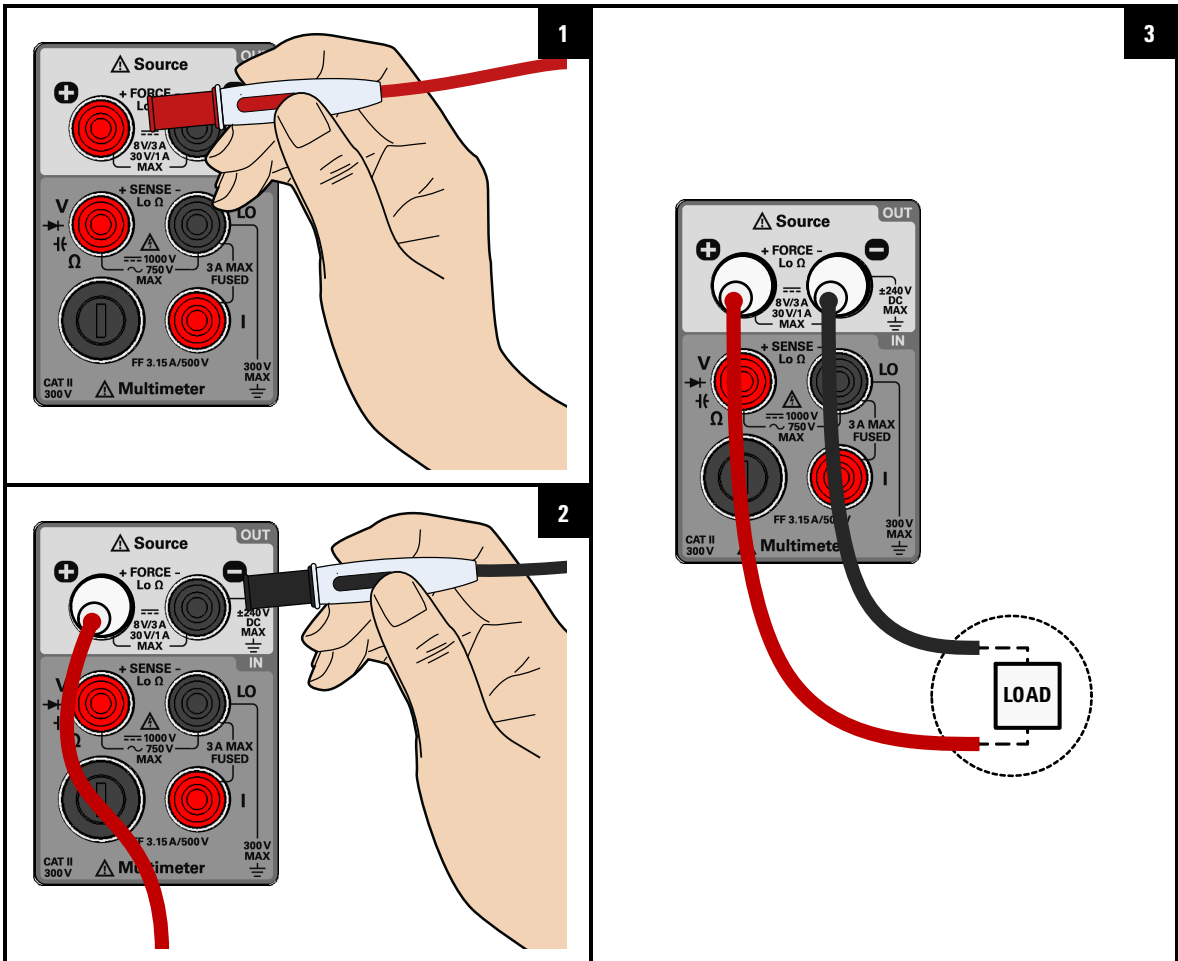

Select the constant voltage or constant current function

4

5

The CV or CC annunciator will turn on according to your selection.

Select the scan function and enable the output

6

Press [**Sweep**] to switch the between ramp and scan functions.

The Scan annunciator will turn on according to your selection.

7

3 DC Power Supply Operation

Sweep Functions

NOTE

- The scan dwell time also affects the first step at amplitude 0. An initial delay, the length of the preset scan dwell time, is expected for each complete scan signal sweep.
 - If you want to adjust the scan signal parameters, press [**Shift**] > [**Utility**] to access the Utility menu.
 - The maximum amplitude end position will be limited by the range and function (CV or CC) selected.
-

Selecting a Range

You can allow the U3606B to automatically select the range using autoranging or you can select a fixed range using manual ranging.



Key	Description
 	Press [Shift] > [Range] to toggle between the available ranges.

Table 3-6 Available ranges for DC power supply functions

Range	CV ^[1]	CC ^[2]	Square wave
S1 (30 V/1 A)	✓	✓	✓
S2 (8 V/3 A)	✓	✓	✓
S1m (30 V/100 mA)	-	✓	-
S2m (1000 mV/3 A)	✓	-	-
S1S2 (autoranging)	✓	✓	✓

[1] Available ranges affect sweep functions (ramp and scan), OCP, and OC values.

[2] Available ranges affect sweep functions (ramp and scan), OVP, and OV values.

NOTE

- The S1 range is selected by default. You cannot change the range when the output is enabled (OUT). The output should always be on stand-by (SBY) before the range or output function can be changed.
- The protection and limit values will always be set to the previous saved value with respect to the range selected when the range is changed.

Enabling the Output

Press [$\frac{\text{OUT}}{\text{SBY}}$] to turn the U3606B output on or off.

With the output off, adjustments can be made to the U3606B or the load without shutting off power to the instrument.

- When the output is disabled, the output voltage and current go to zero, and the SBY annunciator is illuminated.
- When the output is enabled, the U3606B regulates the output voltage and current at the selected value, and the OUT annunciator is illuminated.

The output state is stored in volatile memory; the output is always disabled when power has been turned off or after a remote interface reset.

Remote Sensing

Remote sensing is used to maintain regulation at the load and reduce degradation of regulation that would occur due to the voltage drop in the leads between the power supply and the load. Use remote sensing in applications where load regulation at the load is critical.

Remote sensing is especially useful in constant voltage mode with load impedances that vary or have significant lead resistance. It has no effect in constant current mode. Because sensing is independent of other U3606B functions, it can be used regardless of how the U3606B is programmed. With remote sensing, voltage readback monitors the load voltage at the remote sense points.

By connecting the power supply for remote voltage sensing, voltage is sensed at the load rather than at the U3606B output terminals (+ FORCE -). This will allow the U3606B to automatically compensate for the voltage drop in applications with long lead lengths as well as to accurately read back the voltage across the load.

Refer to [Chapter 5, “Characteristics and Specifications,” starting on page 155](#) for the maximum allowable voltage drop on the load wires.

Use twisted or shielded wires to minimize noise pick-up. If shielded wires are used, the shield should be connected to the ground at one point, either at the power supply chassis or the load ground. The optimal point for the shield ground should be determined by experimentation.

NOTE

During remote sensing setup, it is strongly recommended to power off the instrument to avoid undesirable damage to the load or the U3606B.

3 DC Power Supply Operation

Remote Sensing

Remote sensing connections

Remote sensing requires connecting the load leads from the rear output terminals to the load as shown below. Observe the polarity when connecting the sensing leads to the load.

NOTE

The metal shorting bars should be removed from the rear output and sense terminals for remote sensing connections. For local voltage sensing connections, the sense leads must be connected to the output terminals.

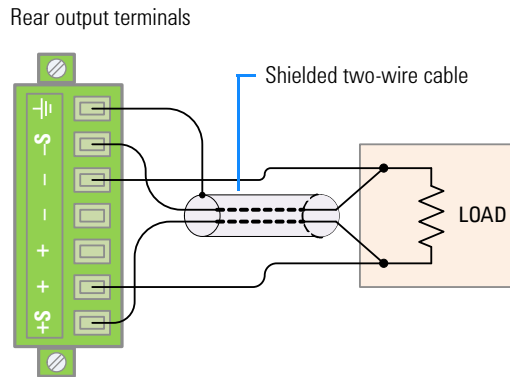

Figure 3-1 Remote sensing connections

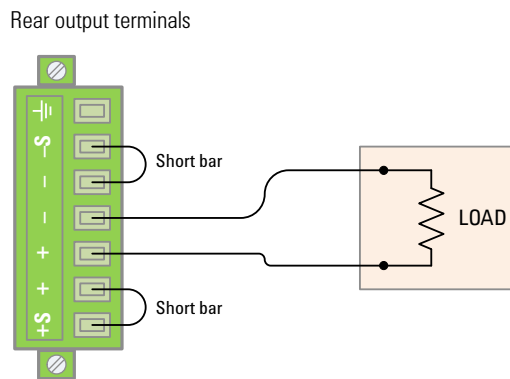
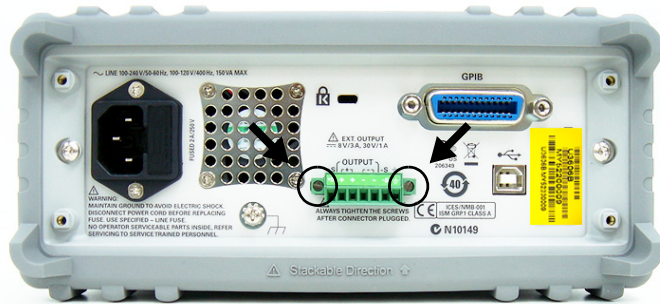

Figure 3-2 Local sensing connections

Connecting the load leads to the rear terminal block

- 1 Turn off the power. Remove all connections between the front output terminals and the load. Remove any metal shorting bars connected to the rear output terminals.
- 2 Loosen the two captive screws in the rear output terminal block with a slotted screwdriver.



- 3 Gently pull the rear output terminal block out.

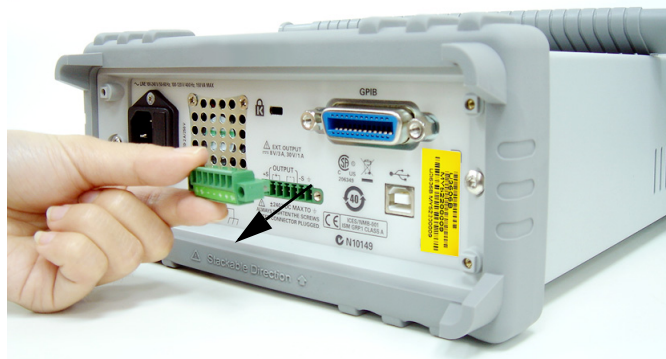

3 DC Power Supply Operation

Remote Sensing

- 4 Loosen the top screws with a slotted screw driver and connect the rear output terminal block sensing (S+ and S-) and output (+ and -) terminals to the load as shown in [Figure 3-1](#) using a shielded two-wire cable.



Do not use the shield as one of the sensing conductors. Ground the shield at the U3606B end only. The other end of the shield should be left unconnected. Observe the polarity when connecting the sensing leads to the load. You can connect the output leads to either one of the two + or - terminals. They are internally shorted.

NOTE

The sensing outputs (S+ and S-) must not be left unconnected. It must be connected locally ([Figure 3-2](#)) or remotely ([Figure 3-1](#)).

- 5 Tighten the top screws of the rear output terminal block to secure firmly the sensing and output connections.
- 6 Place the rear output terminal block back in place and tighten the two captive screws again.

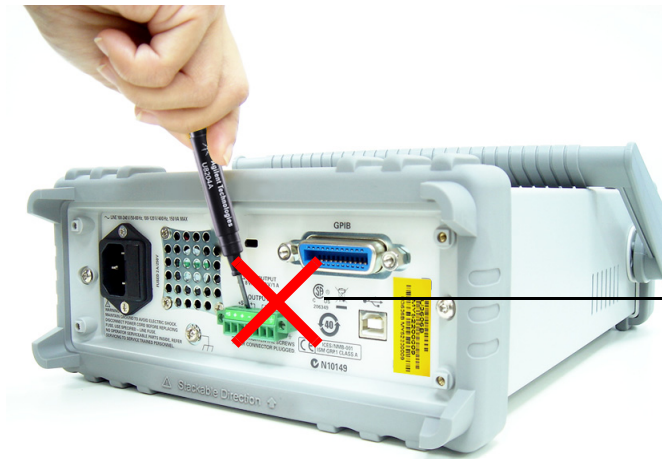

Do not loosen the top screws of the rear output terminal block at a tilted angled.

CAUTION

Avoid connecting the load leads from the rear terminal block to the load as shown above. Loosening the top screws at an inclined angle will damage the terminal block screws.

3 DC Power Supply Operation

Remote Sensing

Enable remote sensing

To configure the U3606B for remote sensing:

- 1 Turn off the U3606B.
- 2 Remove the connections between the U3606B sensing (S+ and S-) and output (+ and -) terminals. Using a shielded two-wire cable, connect the U3606B sensing terminals to the load as shown in **Figure 3-1**. Observe the polarity when connecting the sensing leads to the load.

CAUTION

Do not use the shield as one of the sensing conductors. The other end of the shielded two-wire cable should be left unconnected.

- 3 Turn on the U3606B.
- 4 Press **[Voltage]** to select the constant voltage mode. Use the arrow keys to select the appropriate constant voltage value.
- 5 Press **[Shift] > [EXT]** to enable remote sensing. When the U3606B is operating in remote sensing mode, the EXT annunciator on the front panel is illuminated.

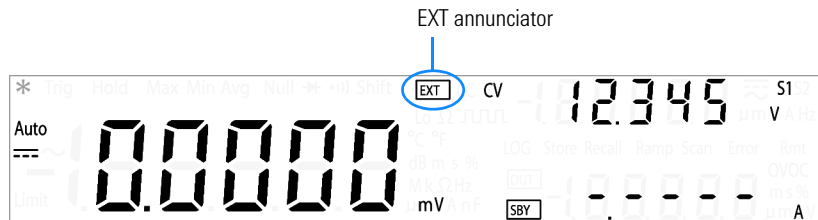

- 6 Press **[$\frac{OUT}{SBY}$]** to regulate the output voltage.
- 7 Press **[Shift] > [EXT]** again to disable remote sensing when the output state is on standby.

NOTE

If the power supply is operated with remote sensing and either the positive or negative load wire is not connected, an internal protection circuit will activate and shut down the power supply. To resume operation, turn the power supply off, connect the open load wire, and turn on the power supply.

Stability

Using remote sensing under certain combinations of load lead lengths and large load capacitances may cause your application to form a filter, which becomes part of the voltage feedback loop. The extra phase shift created by this filter can degrade the instrument stability, resulting in poor transient response or loop instability. In severe cases, it may cause oscillations.

To minimize this possibility, keep the load leads as short as possible and twist them together. As the sense leads are part of the instrument programming feedback loop, accidental open-connections of sense or load leads during remote sensing operation have various unwanted effects. Provide secure and permanent connections.

CV regulation

The voltage load regulation specification in [Chapter 5, “Characteristics and Specifications,” starting on page 155](#) applies at the output terminals of the U3606B. When remote sensing, add 5 mV to this specification for each 1 V drop between the positive sensing point (S+) and output terminals (+) due to the change in load current. Because the sense leads are part of the U3606B feedback path, keep the resistance of the sense leads at or below 0.5 Ω per lead to maintain the above specified performance.

Output rating

The rated output voltage and current specifications in [Chapter 5, “Characteristics and Specifications,” starting on page 155](#) apply at the output terminals of the power supply.

3 DC Power Supply Operation

Remote Sensing

With remote sensing, any voltage dropped in the load leads must be added to the load voltage to calculate maximum output voltage. The performance specifications are not guaranteed when the maximum output voltage is exceeded.

Output noise

Any noise picked up on the sense leads also appears at the output of the U3606B and may adversely affect the voltage load regulation. Twist the sense leads to minimize external noise pickup and run them parallel and close to the load leads. In noisy environments it may be necessary to shield the sense leads. Ground the shield at the U3606B end only. Do not use the shield as one of the sense conductors.

4

System-Related Operation

Using the Utility Menu	124
Utility Menu Summary	126
Utility Menu Items	129
Reading error messages	129
Configuring the data logging parameters	130
Recording measurement data (data logging)	131
Enabling refresh hold	132
Setting the smooth function	133
Configuring the scan signal parameters	136
Configuring the ramp signal parameters	138
Setting the output protection state	140
Adjusting the soft start output	141
Selecting a dBm reference resistance value	142
Performing a self-test	142
Connecting to a remote interface	143
Configuring the beeper	144
Changing the power-on state	145
Adjusting the display brightness	146
Reading the program code revision	146
Storing and Recalling Instrument States	147
Storing a state	148
Recalling a stored state	149
Remote Operation	150
Configuring and connecting the GPIB interface	151
Configuring and connecting the USB interface	152
SCPI commands	152











This chapter lists the various items in the Utility menu as well as other system-related operations.

Using the Utility Menu

The Utility menu allows you to customize a number of non-volatile instrument configurations. Modifying these settings affects the operation of your instrument across several functions. Select the setting you want to edit to do the following:

- Switch between two values, such as on or off.
- Select a value from the list.
- Decrease or increase a value by using the directional keys.

The Utility menu also displays error messages and hardware revision codes. The contents of the Utility menu are summarized in [Table 4-1](#).

Key	Description
 	Press [Shift] > [Utility] to access the Utility menu.
 	Press [<] or [>] to step through the menu items.
 	Press [Δ] or [∇] to switch between two values, to select a value from the list, or to decrease or increase a value.
 	Press [Shift] > [Save] to save a setting.
 	Press [Shift] > [Exit] to exit the edit mode without saving or to exit the Utility menu.

Press **[Shift]** > **[Utility]** to enter the Utility menu. The first menu item allows you to read error messages.

1



Use the arrow keys to navigate the Utility menu.

2

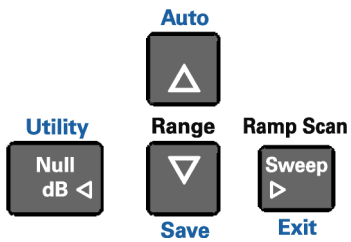

- Press [**◀**] or [**▶**] to step through the available menu items.
- Press [**▲**] or [**▼**] to switch between two values, to select a value from the list, or to decrease or increase a value.

Press **[Shift]** > **[Save]** to save a changed setting.

3

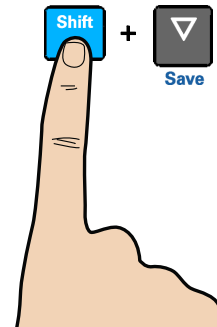

Press **[Shift]** > **[Exit]** to exit the Utility menu.

4

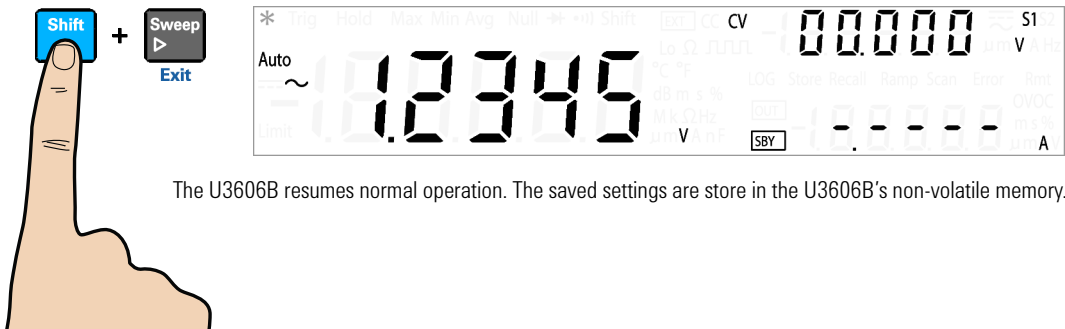

The U3606B resumes normal operation. The saved settings are store in the U3606B's non-volatile memory.

Utility Menu Summary

The Utility menu items are summarized in the table below. For further explanations on the various items in the Utility menu, see the respective menu item headings.

Table 4-1 Utility menu summary

Item	Available settings		Description	Link	
Error	nonE	(-)Er.NNN	<ul style="list-style-type: none"> Review the last recorded error message (up to 20 error messages). Review all the recorded error messages to clear the Error annunciator. 	page 129	
dAtA	NNNNN	NNNNN s	<ul style="list-style-type: none"> Set the data logging loop number (NNNNN) from 1 to 29000. Set the data logging interval time (NNNNN s) from 1 s to 99999 s. 	page 130	
LoG FiLE	StoP	Cont	StArt	<ul style="list-style-type: none"> Select "StArt" to start the data logging operation (this operation overwrites any previously logged data). Select "StoP" to stop the data logging operation. Select "Cont" to resume a data logging operation from where it was last stopped. 	page 131
rHoLd	t - NNN %	nH - N.N %	<ul style="list-style-type: none"> Set the refresh hold variation (t - NNN %) in percentage. When the variation of the measuring value exceeds the preset setting, the refresh hold will be ready to trigger. Set variation to "oFF" to enable data hold mode. Set the refresh hold threshold (nH - N.N %) in percentage for voltage, current, and capacitance measurements. The reading value will not be updated when the reading falls below the threshold value. 	page 132	

Table 4-1 Utility menu summary (continued)

Item	Available settings		Description	Link
SMoth	oF	on	Select “oF” to disable the smooth function, or “on” to enable the smooth function.	
	FC-N.N %		<ul style="list-style-type: none"> Set the fluctuation count from 0.0 % to 9.9 %. Set the count to 0.0 % to disable the fluctuation function. 	page 133
	NNNN		Set the number of points from 2 to 1999.	
SCAn	CV	CC	<ul style="list-style-type: none"> Press [Voltage] to select scan setup for CV. Press [Current] to select scan setup for CC. 	
	S1/S2/S2m	S1/S1m/S2	Press [Shift] > [Range] to toggle between range S1 (30 V/1 A), S1m (30 V/100 mA), S2 (8 V/3 A), or S2m (1000 mV/3 A)	
	NN.NNN V	N.NNNN A	NNN-NN s	<ul style="list-style-type: none"> The increment of each step will be the amplitude end position (NNNN.N mV/ NNN.NN mA) divided by the number of steps (NNN). Set the scan dwelling time (NN s) from 1 s to 99 s.
rAMP	CV	CC	<ul style="list-style-type: none"> Press [Voltage] to select ramp setup for CV. Press [Current] to select ramp setup for CC. 	
	S1/S2/S2m	S1/S1m/S2	Press [Shift] > [Range] to toggle between range S1 (30 V/1 A), S1m (30 V/100 mA), S2 (8 V/3 A), or S2m (1000 mV/3 A)	
	NN.NNN V	N.NNNN A	NNNNN	<ul style="list-style-type: none"> The increment of each step will be the amplitude end position (NNNN.N mV/ NNN.NN mA) divided by the number of steps (NNNNN). The ramp dwelling time will be fastest of output capability (typically ~100 ms per step).
triP	YES	no	<ul style="list-style-type: none"> Select “YES” to enable the output protection or “no” to disable the output protection. The factory default for the output protection state is “YES”. 	page 140
SoFt.S StEP	NNNNN		Set the soft start rising step from 1 to 10000.	page 141

4 System-Related Operation

Utility Menu Summary

Table 4-1 Utility menu summary (continued)

Item	Available settings			Description	Link
db.rEF	NNNN Ω			Set dB reference impedance value from 1 Ω to 9999 Ω .	page 142
SELF.t	no	YES		<ul style="list-style-type: none"> If "YES" is selected, the instrument exits the Utility menu and immediately executes the self-test. After the self-test completes, the instrument returns to normal operation. 	page 142
iob	GPib	U-CdC	U-tMC	<ul style="list-style-type: none"> Select "GPib", "U-tMC", or "U-CdC" as the desired remote interface connection. "USB-tMC" simulates the USB interface according to USB-TMC standard. "USB-CdC" is used to simulate the communication port. 	page 143
	NN			Set the GPIB address from 1 to 30.	
bEEP	2400 Hz	3840 Hz	oFF	<ul style="list-style-type: none"> Set the beep driving frequency to "2400 Hz" or "3840 Hz". Set "oFF" to disable the beep tone. 	page 144
P-on	rESEt	LAsT		<ul style="list-style-type: none"> Set "LAsT" to recall the last known power-off state when power is turned on. Set "rESEt" to recall the default factory power-on state when power is turned on. 	page 145
diSP	L-03	L-02	L-01	Cycle through the VFD display brightness levels.	page 146
P.CodE	NN.NN iob	NN.NN Sb	NN.NN Mb	<ul style="list-style-type: none"> Select "iob" to view interface board program code revision. Select "Sb" to view source board program code revision. Select "Mb" to view measurement board program code revision. 	page 146

Utility Menu Items

Reading error messages



If there are no errors in the error queue, the primary display shows “nonE”.

If there are one or more errors, “totAL” is shown in the primary display and “NN” is shown in the lower secondary display (where “NN” is the total number of errors in the error queue). For example, if there are seven errors in the queue, “07” will be shown in the lower secondary display.



Errors are numbered and stored in the queue in the order they occurred.

If there are errors in the error queue, press [▽] to read the first error. The error number in the queue is shown in the primary display, “(-)Er.NNN”, where “NNN” is the actual error number.



4 System-Related Operation

Utility Menu Items

Press [∇] again to read the remaining errors. The error queue is automatically cleared when all errors have been read (primary display shows “nonE”).

Configuring the data logging parameters



The data logging function provides you the convenience of recording test data for future review or analysis. Since data is stored in the non-volatile memory, the data remains saved even when the U3606B is turned OFF.

The data logging feature collects measurement information over a user-specified duration.

Press [Δ] or [∇] to change the data logging loop number (1 to 29000).

Press [\triangleleft] or [\triangleright] until the cursor is position on the data logging interval. Press [Δ] or [∇] to change the data logging interval (1 to 99999 s).

NOTE

- You can record up to 28800 data (8 hours \times 60 minutes \times 60 seconds).
- The data logging operation will stop automatically when it is completed or when the U3606B’s memory is full.

Recording measurement data (data logging)



Press [Δ] or [∇] to switch between “StoP”, “Cont”, or “StArt”.

Select “StArt” to start the data logging operation, select “StoP” to stop the data logging operation, and select “Cont” to resume a data logging operation from where it was last stopped.



If “StArt” is selected, the U3606B will exit the Utility menu immediately and begin the data logging operation. The LOG annunciator turns on for the entire duration of the data logging operation.



NOTE

- Selecting “StArt” overwrites any previously stored data. After the data logging operation has started, you will need to press [**Local**] if you want to stop the data logging operation.
- The data logging operation will stop automatically when it is completed or when the U3606B’s memory is full.
- To download the stored data, you will need to connect a PC to the U3606B via remote operation. See the *U3606B Programmer’s Reference* for more details.

Enabling refresh hold



Press [Δ] or [∇] to change the refresh hold variation (001% to 100%).

Press [\leftarrow] or [\rightarrow] until the cursor is position on the refresh hold threshold (nH - N.N%). Press [Δ] or [∇] to change the refresh hold threshold (0.0% to 9.9%) for voltage, current, and capacitance measurements.

NOTE

- If the variation of the measured value exceeds the preset percentage, the refresh hold will be ready to trigger.
- For voltage, current, and capacitance measurements, the reading value will not be updated when the reading falls below the threshold value.

Setting the smooth function



The smooth function is a special short-term average that differs from the average function of the MinMax operation. The smooth function filters noise and stabilizes readings. The average function of the MinMax operation is considered as a long-term average as it uses all of the readings to perform averaging.

The smooth function has a fixed number of readings that will be used for averaging. This fixed number is known as the number of points which you can set from the Utility menu. The smooth function also includes a fluctuation count which limits the range of the readings that can be used for the averaging. Smoothed readings obtained using the smooth function are easier to read as the readings are stabilized.

The smooth function and the average function of the MinMax operation are independent functions and mutually exclusive in which they cannot occur at the same time.

When the smooth function is enabled, the AVG annunciator will be flashing to indicate its ON state. The smooth function will start its calculations using the parameters set in the Utility menu.

NOTE

The smooth function calculation can be restarted by pressing [**MinMax**] for more than one second.

Press [Δ] or [∇] to enable or disable the smooth function (“on” or “oF”).

4 System-Related Operation

Utility Menu Items



To set the fluctuation count, press [▷] until the cursor position is on the fluctuation count at the secondary display. Press [◀] or [▶] to change the cursor position and [Δ] or [▽] to change the value for the fluctuation count (0.0% to 9.9%).

NOTE

- The range of values for the fluctuation count is from 0.0% to 9.9%, with the default value at 1.0%.
- If the input raw signal readings are higher or lower than the fluctuation count of the previous smoothed signal readings, the smooth function calculations will reset.

For example, a smooth function with a 5 V signal and a fluctuation count of 1.0% will only smooth the input raw signal to the existing smooth calculation if the input signal is between 4.9 V and 5.1 V. The next input signal will then be compared to the newly smoothed signal. If the input signal is out of the set fluctuation count range of the smoothed signal, the smooth function calculation will reset and restart at the out-of-range signal.

- The smooth function will also reset if the range of the signal changes when the smooth calculation is running. For example, when the signal range jumps to the 100 V range from the 10 V range.
- You can also manually restart the smooth function by pressing [MinMax] for more than one second.
- Setting the fluctuation count to 0.0% will disable the fluctuation count. It is recommended that the fluctuation count is enabled.

To set the number of points, press [\blacktriangleleft] until the cursor position is on the number of points on the primary display. Press [\blacktriangleleft] or [\blacktriangleright] to change the cursor position and [\blacktriangle] or [\blacktriangledown] to change the values for the number of points (2 to 1999).

NOTE

- The range of values for the number of points is from 2 to 1999, with the default value at 10.
- The number of readings used to perform the smooth function calculation depends on the number of points set. For example, if the number of points is set to 10 ($N = 10$), the smooth function will only use a maximum of 10 readings for averaging instead of an incremental value as used in the average function of the MinMax operation. When the instrument reaches the 11th reading or more, it will take the previous averaged value multiply by $(N-1)$, and the current value to perform the averaging. Note the difference given below between the smooth function and average function for a x number of readings:

Smooth function

$$\begin{aligned}
 V_1 &= r_1 \\
 V_2 &= (r_1 + r_2)/2 \\
 V_3 &= (r_1 + r_2 + r_3)/3 \\
 &\dots \\
 V_{10} &= (r_1 + r_2 + \dots + r_{10})/10 \\
 V_{11} &= (V_{10} * 9 + r_{11})/10 \\
 V_{12} &= [(V_{11} * 9) + r_{12}]/10 \\
 &\dots \\
 V_{x-1} &= [(V_{x-2} * 9) + r_{x-1}]/10 \\
 V_x &= [(V_{x-1} * 9) + r_x]/10
 \end{aligned}$$

Average function

$$\begin{aligned}
 V_1 &= r_1 \\
 V_2 &= (r_1 + r_2)/2 \\
 V_3 &= (r_1 + r_2 + r_3)/3 \\
 &\dots \\
 V_{10} &= (r_1 + r_2 + \dots + r_{10})/10 \\
 V_{11} &= (r_1 + r_2 + \dots + r_{10} + r_{11})/11 \\
 V_{12} &= (r_1 + r_2 + \dots + r_{11} + r_{12})/12 \\
 &\dots \\
 V_{x-1} &= [r_1 + r_2 + \dots + r_{x-2} + r_{x-1}]/(x-1) \\
 V_x &= [r_1 + r_2 + \dots + r_{x-1} + r_x]/x
 \end{aligned}$$

Configuring the scan signal parameters



Press **[Voltage]** or **[Current]** if you wish to configure the scan signal parameters for CV or CC output.

Select an appropriate output range by pressing **[Shift]** > **[Range]**. The scan signal amplitude end position is limited by the range selected.

Table 4-2 Scan signal parameters

Scan signal	Output					
	Constant Voltage			Constant Current		
Items	S1	S2	S2m	S1	S2	S1m
Range ^[1]	S1	S2	S2m	S1	S2	S1m
Amplitude end position ^[2]	0 V to 31.500 V	0 V to 8.400 V	0 V to 1050.0 mV	0 A to 1.0500 A	0 A to 3.1500 A	0 A to 105.00 mA
Number of steps	1 step to 100 steps					
Dwelling time	1 s to 99 s					

[1] Range S1S2 (autoranging) is not supported for the Scan function.

[2] Amplitude start position is fixed at 0 (V or A) by default.

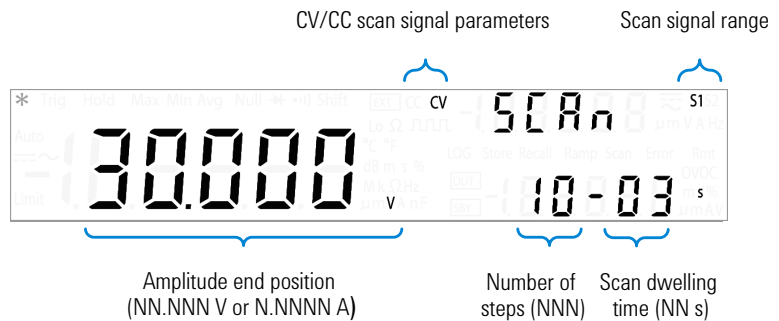

Press [Δ] or [∇] to change the scan signal amplitude end position.

Press [\leftarrow] or [\rightarrow] until the cursor is position on the scan signal number of steps. Press [Δ] or [∇] to change the number of steps for the scan signal to increment from zero to the amplitude end position.

Press [\leftarrow] or [\rightarrow] until the cursor is position on the scan signal dwelling time. Press [Δ] or [∇] to change the scan signal dwelling time.

NOTE

- The increment of each step in the scan signal will be the amplitude end position divided by the number of steps. For example, a 15 V amplitude end position divided by 100 steps gives an increment of 0.15 V per step.
- The scan signal will “dwell” in the present step for the length of time stated in the scan dwelling time before incrementing to the next step.

Configuring the ramp signal parameters



Press **[Voltage]** or **[Current]** if you wish to configure the scan signal parameters for CV or CC output.

Select an appropriate output range by pressing **[Shift]** > **[Range]**. The ramp signal amplitude end position is limited by the range selected.

Table 4-3 Ramp signal parameters

Ramp signal	Output					
	Constant Voltage			Constant Current		
Items	S1	S2	S2m	S1	S2	S1m
Range ^[1]	S1	S2	S2m	S1	S2	S1m
Amplitude end position ^[2]	0 V to 31.500 V	0 V to 8.400 V	0 V to 1050.0 mV	0 A to 1.0500 A	0 A to 3.1500 A	0 A to 105.00 mA
Number of steps	1 step to 10000 steps					
Dwelling time	Fastest of the instrument output capability ^[3]					

[1] Range S1S2 (autoranging) is not supported for the Ramp function.

[2] Amplitude start position is fixed at 0 (V or A) by default.

[3] Typically ~100 ms per step.

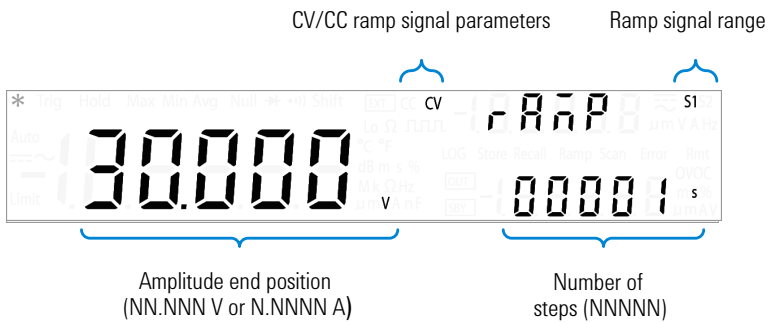

Press [Δ] or [▽] to change the ramp signal amplitude end position.

Press [◀] or [▶] until the cursor is position on the ramp signal number of steps. Press [Δ] or [▽] to change the number of steps for the ramp signal to increment from zero to the amplitude end position.

NOTE

- The increment of each step in the ramp signal will be the amplitude end position divided by the number of steps. For example, a 15 V amplitude end position divided by 100 steps gives an increment of 0.15 V per step.
- The ramp dwelling time selected will be fastest of the instrument output capability. (Typically ~100 ms per step.)

Setting the output protection state



The OVP and OCP features depend on the output protection state function. The output protection state must be enabled for the OVP and OCP features to be active in the circuit. Disabling the output protection state will deactivate both the OVP and OCP features even if a trip level is set for either the OVP or OCP.

NOTE

The output protection state does not affect the over-voltage and over-current limits.

CAUTION

- Disabling the output protection state may result in equipment damage if an over-voltage or over-current condition occurs. It is recommended to have the output protection state enabled.
- In the event that there is a large current over the system protection values (Table 4-4), the U3606B will trip to protect itself even if the triP option in Utility menu is set to “no”.

Table 4-4 System protection values

Range	System protection (approx.)
S1 (30 V/1 A)	1.3 A
S1m (30 V/100 mA)	230 mA
S2 (8 V/3 A)	3.5 A
S2m (1000 mV/3 A)	3.5 A
S1S2 (autoranging)	3.5 A

Press [Δ] or [▽] to switch between “YES” and “no”. Select “YES” to enable the output protection state or “no” to disable the output protection state.



Adjusting the soft start output



The U3606B allows you the option of soft starting the DC power supply output. You can select a value from 1 to 10000 steps for the soft start output. This feature is useful to start a DC motor. The factory default soft start step value is 1.

Press [Δ] or [▽] to change the soft start step value (1 to 10000).

NOTE

For a successful fast starting DC motor (1 step), you must first disable the output protection (page 140) and change the constant voltage range to S1S2 (autoranging). Selecting longer rising steps such as 30 to 50 steps can reduce the starting current of the DC motor.

Selecting a dBm reference resistance value



The dBm function is logarithmic, and is based on a calculation of power delivered to a reference resistance, relative to 1 mW. The following procedure shows you how to select an appropriate dBm reference resistance value. The factory default dBm reference resistance value is 600 Ω .

Press [Δ] or [∇] to change the dBm reference resistance value (0001 Ω to 9999 Ω).

Performing a self-test



A power-on self-test occurs immediately when you turn on the instrument. This limited test assures you that the U3606B is operational.

The following procedure shows you how to perform a more extensive self-test. A complete self-test performs a series of internal tests, and may take up to 30 seconds to complete. For remote interface operation, refer to the *TST command in the *U3606B Programmer's Reference*.

CAUTION

Before performing the complete self-test, ensure that all test leads are removed from the input and output terminals.



Press [Δ] or [∇] to select “YES” and then press [**Shift**] > [**Save**] to save. The instrument will automatically exit the Utility menu and execute the self-test.

If the self-test is successful, the U3606B will return to normal operation.

If the power-on or complete self-test fails, the Error annunciator illuminates, and an error is stored in the error queue.

Connecting to a remote interface



Press [Δ] or [∇] to change the remote interface connection (GPiB, U-CdC, or U-tMC).

To change the GPIB address, press [Δ] or [∇] until the menu item “GPiB” is flashing.

Press [\triangleright] to position the cursor on the GPIB address number. Use the directional keys to select an appropriate GPIB address from 1 to 30.

NOTE

See “Remote Operation” on page 150 for more information on the available remote interface connections.

Configuring the beeper



Normally, the U3606B beeps whenever certain conditions are met (for example, the U3606B beeps when a stable reading is captured in reading hold mode). The beep driving frequency is set to “3840 Hz” by default, but may be disabled through the front panel.

When the beep driving frequency is set to “2400 Hz” or “3840 Hz”, a single beep occurs for the following cases (turning the beeper “oFF” disables the beep for the following cases):

- When a new minimum (Min) or maximum (Max) value is stored.
- When a new stable reading is updated on display for hold operation.
- When a measurement exceeds the high (HI) or low (LO) limit value.
- When a forward-biased diode is measured in the diode function.
- When a continuity measurement is less than or equal to the continuity threshold.
- When a `SYSTEM:BEEPER` command is sent from the remote interface.
- When an error is generated.

Press [Δ] or [∇] to change the beep driving frequency. Select “oFF” to disable the beeper.

Changing the power-on state



The following procedure shows you how to enable or disable the automatic recall of the power-off state when the power is turned on. For remote interface operation, refer to the `MEMory:STATe:RECall:AUTO` command in the *U3606B Programmer's Reference*.

Press [Δ] or [∇] to change the power-on state.

- Select “rESEt” to automatically reset the instrument to the factory default state when the power is turned on.
- Select “LAsT” to automatically recall the last power-off state of the instrument when the power is turned on.



NOTE

The power-off state includes

- the multimeter function, autoranging state, measurement range and resolution, and frequency path
- the DC power supply function, range, remote sensing, square-wave, amplitude, frequency, duty-cycle, and pulse-width

The power-off state does not include

- math operations
- ramp, scan, and protection and limitation^[1] functions

[1] Although the U3606B does not store the power-off protection and limitation of the source, it can recall your saved settings by remote or local operation when you select “LAST”.

Adjusting the display brightness



Press [Δ] or [∇] to cycle between the available brightness levels (L-01, L-02, or L-03).

Reading the program code revision



Press [Δ] or [∇] to cycle between the interface board (iob), source board (Sb), and measurement board (Mb) program code revisions.

Storing and Recalling Instrument States

You can save and recall complete instrument states.

There are sixteen user storage registers numbered 1 through 16. An additional state, state 0, is managed by the instrument and stores the last power-down state. The instrument automatically saves the complete instrument configuration to state 00 whenever a power-down event occurs.

For remote operation, refer to the `MEMory:STATe:RECall:AUTO`, `*SAV`, and `*RCL` commands in the *U3606B Programmer's Reference*.

4 System-Related Operation

Storing and Recalling Instrument States

Storing a state

To store an instrument state

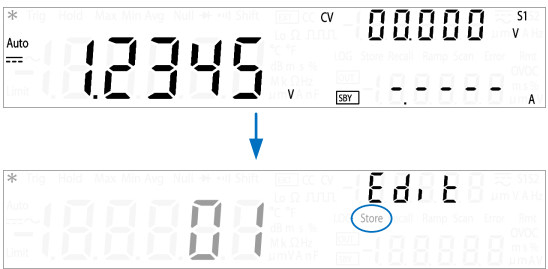

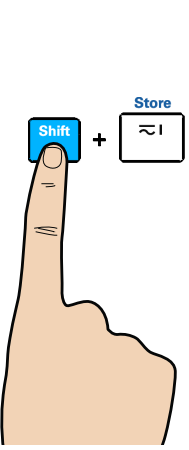

1

Use the arrow keys to navigate the edit mode.

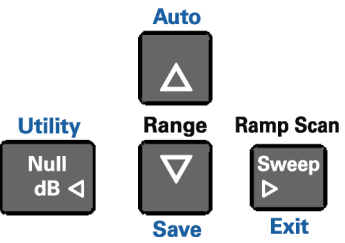

Press [Δ] or [∇] until the state number (01 to 16) you want to store to is shown on the primary display.

To store to the selected state

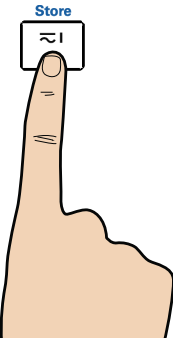

3

NOTE

You can also press [Shift] > [Save] to store the selected state.

Recalling a stored state

To recall an instrument state

1

2

Use the arrow keys to navigate the edit mode.

Utility

Null
dB ◀

Auto

▲

Range

▼

Save

Ramp Scan

▶

Exit

Press [▲] or [▼] until the state number (00 to 16) you want to recall from is shown on the primary display.

3

To recall the selected state

NOTE

- You can also press **[Shift]** > **[Save]** to recall the selected state.
- Select state 00 to recall the instrument last power-down state.

U3606B User's Guide

149

Remote Operation

The U3606B is shipped with both a GPIB (IEEE-488) interface and a USB 2.0 interface on the rear panel. Only one interface can be enabled at a time. The GPIB interface is selected by default when the U3606B is shipped from the factory.

The remote interface can be selected from the front-panel only.

- The interface selection is stored in the non-volatile memory, and does not change when power is turned off or after a remote interface reset.
- If you select the GPIB interface, you must select a unique address for the U3606B. The current address for the U3606B is displayed on the lower secondary display in the Utility menu.
- You can select between two USB class: USB-TMC or USB-CDC. USB-TMC is the default USB 2.0 full-speed communication protocol interface that is compliant to USB standards, while USB-CDC is simulates a serial communication (RS-232) interface at the PC through the physical USB port connection.

The instrument automatically enters the remote state whenever SCPI commands are received over the GPIB or USB interface. The Rmt annunciator is illuminated and the front panel keys are locked when in the remote state. Press **[Local]** to return the U3606B to front panel operation.

Configuring and connecting the GPIB interface

The GPIB (IEEE-488) connector on the rear panel connects your U3606B to a computer and other GPIB devices. A GPIB system can be connected together in any configuration (star, linear, or both) as long as the following rules are observed.

- The total number of devices including the computer is no more than 15.
- The total length of all the cables used is no more than 2 meter times the number of devices connected together, up to a maximum of 20 meters.

NOTE

IEEE-488 states that you should exercise caution if your individual cable lengths exceed 4 meters.

Do not stack more than three connector blocks together on any GPIB connector. Make sure that all connectors are fully seated and that the lock screws are firmly finger tightened.

GPIB address

Each device on the GPIB interface must have a unique address. You can set the U3606B address to any value between 1 and 30. The current address is displayed on the secondary display at the bottom left. The address is set to “01” when the U3606B is shipped from the factory.

The GPIB address can be set from the front panel only.

- The address is stored in the non-volatile memory, and does not change when power is turned off or after a remote interface reset.
- Your GPIB bus controller has its own address. Be sure to avoid using the bus controller address for any instrument on the interface bus. Keysight Technologies controllers generally use the address “21”.

Configuring and connecting the USB interface

Select the appropriate USB class for communication from the Utility menu.

- USB-TMC stands for USB Test and Measurement Class. USB-TMC is a protocol built on top of USB that allows GPIB-like communication with USB devices.
- USB-CDC stands for USB Communications Device Class. USB-CDC is a composite Universal Serial Bus device class. It provides a single device class, but there may be more than one interface implemented such as a custom control interface, data interface, audio, or mass storage related interfaces. To install the USB-CDC driver, see the *USB-CDC Driver Installation Guide* in the *U3606B Product Reference CD-ROM*.

Then, connect the instrument to your PC using the USB 2.0 cable included with the instrument.

NOTE

- To easily configure and verify an interface connection between the U3606B and your PC, refer to the *USB/LAN/GPIB Interfaces Connectivity Guide*, located in the *Keysight Automation-Ready CD-ROM*, which is shipped with your instrument.
- This CD includes the Keysight IO Libraries Suite and the Keysight Connection Expert application. For more information about Keysight's I/O connectivity software, visit www.keysight.com/find/iolib.

SCPI commands

The U3606B complies with the syntax rules and conventions of SCPI (Standard Commands for Programmable Instruments).

NOTE

For a complete discussion of all the U3606B SCPI syntax available, refer to the *U3606B Programmer's Reference*. This document is provided on the *U3606B Product Reference CD-ROM* that comes with your instrument.

SCPI language version

You can determine the SCPI language version of the instrument by sending the `SYSTem:VERSion?` command from the remote interface.

- You can query the SCPI version from the remote interface only.
- The SCPI version is returned in the form “YYYY.V”, where “YYYY” represents the year of the version, and “V” represents a version number for that year (for example, 1994.0).

SCPI query time-out

The SCPI query time-out represents the absolute time period (in milliseconds) that the resource waits for the device to respond before this operation returns an error (default value is 5000 milliseconds).

Some measurements may result in a delayed response time in the U3606B. It is recommended that you increase the SCPI query time-out to 15000 milliseconds or longer to avoid SCPI query time-out errors.

Remote programming using SCPI commands

During remote programming, various SCPI commands are stringed together in a single programming module. As the programming module executes each SCPI command sequentially, a 1 millisecond interval between each subsequent SCPI command is recommended to allow the U3606B sufficient command processing time.

4 System-Related Operation
Remote Operation

THIS PAGE HAS BEEN INTENTIONALLY LEFT BLANK.

5 Characteristics and Specifications

Product Characteristics	156
Digital Multimeter Specifications	158
Specification assumptions	158
DC specifications	159
AC specifications	163
Frequency specifications	165
Duty cycle and pulse width specifications	167
Operating specifications	167
Supplemental characteristics	169
DC Power Supply Specifications	175
Safety considerations	175
Specifications assumptions	175
Performance specifications	176
Supplemental characteristics	178

This chapter specifies the characteristics, environmental conditions, and specifications of the U3606B.

Product Characteristics

POWER SUPPLY

- Universal 100 V_{ac} to 240 V_{ac} ±10%
- AC line frequency of 45 Hz to 66 Hz; 360 Hz to 440 Hz for 100/120 V operation

POWER CONSUMPTION

150 VA maximum

CURRENT INPUT FUSE

3.15 A, 500 V FF fuse (on front panel)

DISPLAY

Highly visible vacuum-fluorescent display (VFD)

OPERATING ENVIRONMENT

Refer to “[Environmental Conditions](#)” on page V

STORAGE COMPLIANCE

Refer to “[Environmental Conditions](#)” on page V

SAFETY AND EMC COMPLIANCE

Refer to “[Environmental Conditions](#)” on page V

SHOCK AND VIBRATION

Tested to IEC/EN 60068-2

REMOTE INTERFACE

- GPIB IEEE-488 compatible
- Full Speed USB 2.0 (Standard-A to Type-B)
- USB-TMC 488.2 Class device compatible
- USB-CDC

MEASUREMENT CATEGORY

- CAT II 300 V
- CAT I 1000 V_{dc}, 750 V_{ac} rms
- 2500 V_{pk} transient over-voltages

DIMENSIONS (W × H × D)

- 226 × 105 × 334 mm (with rubber bumpers)
- 215 × 87 × 312 mm (without rubber bumpers)

WEIGHT

- 3.77 kg, approximate (with rubber bumpers)
 - 3.54 kg, approximate (without rubber bumpers)
-

WARRANTY

- Please refer to http://www.keysight.com/go/warranty_terms
 - Three years for the product
 - Three months for the standard accessories unless otherwise specified
- Please note that for the product, the warranty does not cover:
 - Damage from contamination
 - Normal wear and tear of mechanical components
 - Manuals or fuses

CALIBRATION CYCLE

One year

WARM UP TIME

60 minutes

Digital Multimeter Specifications

Specification assumptions

- Specifications stated are for 60 minutes warm-up and 5½ digit resolution.
- One-year calibration cycle, with calibration temperature of 23±2 °C.
- Operating temperature at 18 °C to 28 °C (64.4 °F to 82.4 °F).
- Accuracy is expressed as: ±(% of reading + % of range)
- Temperature coefficient: Add [0.1 × (the applicable accuracy) / °C] for 0 °C to 18 °C and 28 °C to 55 °C.
- Relative humidity (RH) up to 80% at 30 °C, proportional to 50% for 30 °C to 55 °C.

DC specifications

Table 5-1 DC accuracy specifications \pm (% of reading + % of range)

Function	Range ^[1]	Resolution	Test current or burden voltage	24 Hours ^[2] 23 °C \pm 1 °C	90 Days 23 °C \pm 5 °C	1 Year 23 °C \pm 5 °C	Temperature coefficient 0 °C to 18 °C 28 °C to 55 °C
DC voltage	19.9999 mV	0.1 μ V	-	0.012 + 0.04	0.015 + 0.04	0.025 + 0.04	0.0015 + 0.0040
	100.000 mV	1 μ V	-	0.012 + 0.008	0.015 + 0.008	0.025 + 0.008	0.0015 + 0.0008
	1.00000 V	10 μ V	-	0.012 + 0.005	0.015 + 0.005	0.025 + 0.005	0.0010 + 0.0005
	10.0000 V	100 μ V	-	0.012 + 0.005	0.015 + 0.005	0.025 + 0.005	0.0020 + 0.0005
	100.000 V	1 mV	-	0.012 + 0.005	0.015 + 0.005	0.025 + 0.005	0.0015 + 0.0005
	1000.00 V	10 mV	-	0.012 + 0.005	0.015 + 0.005	0.025 + 0.005	0.0015 + 0.0005
DC current ^[3]	10.0000 mA	0.1 μ A	< 0.2 V	0.05 + 0.015	0.05 + 0.015	0.05 + 0.015	0.0060 + 0.0005
	100.000 mA	1 μ A	< 0.2 V	0.05 + 0.005	0.05 + 0.005	0.05 + 0.005	0.0060 + 0.0005
	1.00000 A	10 μ A	< 0.3 V	0.05 + 0.007	0.05 + 0.007	0.15 + 0.007	0.0100 + 0.0005
	3.0000 A	100 μ A	< 0.7 V	0.05 + 0.007	0.05 + 0.007	0.15 + 0.007	0.0150 + 0.0010

5 Characteristics and Specifications

Digital Multimeter Specifications

Table 5-1 DC accuracy specifications \pm (% of reading + % of range) (continued)

Function	Range ^[1]	Resolution	Test current or burden voltage	24 Hours ^[2] 23 °C \pm 1 °C	90 Days 23 °C \pm 5 °C	1 Year 23 °C \pm 5 °C	Temperature coefficient 0 °C to 18 °C 28 °C to 55 °C
Resistance ^[4]	100.000 Ω	1 m Ω	0.83 mA	0.04 + 0.008	0.04 + 0.008	0.05 + 0.008	0.0050 + 0.0005
	1000.00 Ω	10 m Ω	0.83 mA	0.04 + 0.005	0.04 + 0.005	0.05 + 0.005	0.0050 + 0.0005
	10.0000 k Ω	100 m Ω	100 μ A	0.04 + 0.005	0.04 + 0.005	0.05 + 0.005	0.0050 + 0.0005
	100.000 k Ω	1 Ω	10 μ A	0.04 + 0.005	0.04 + 0.005	0.05 + 0.005	0.0050 + 0.0005
	1.00000 M Ω	10 Ω	900 nA	0.05 + 0.005	0.05 + 0.005	0.06 + 0.005	0.0050 + 0.0005
	10.0000 M Ω	100 Ω	205 nA	0.20 + 0.005	0.20 + 0.005	0.25 + 0.005	0.0150 + 0.0005
	100.000 M Ω	1 k Ω	205 nA 10 M Ω	1.60 + 0.005	1.60 + 0.005	2.00 + 0.005	0.1500 + 0.0005
Low-resistance ^[5]	100 m Ω	0.01/ 0.001 m Ω	1.0000 A	-	-	0.25 + 0.05	-
	1000 m Ω	0.1/0.01 m Ω	100.00 mA	-	-	0.25 + 0.03	-
	10 Ω	1/0.1 m Ω	100.00 mA	-	-	0.09 + 0.03	-
	100 Ω	10/1 m Ω	10.00 mA	-	-	0.09 + 0.03	-
	1000 Ω	0.1/10 m Ω	10.00 mA	-	-	0.09 + 0.03	-
Continuity	1.0000 k Ω	100 m Ω	0.83 mA	0.04 + 0.005	0.04 + 0.005	0.05 + 0.005	0.0050 + 0.0005
Diode ^[6]	1.0000 V	0.0001 V	0.83 mA	0.04 + 0.005	0.04 + 0.005	0.05 + 0.005	0.0050 + 0.0005

Table 5-1 DC accuracy specifications ± (% of reading + % of range) (continued)

Function	Range ^[1]	Resolution	Test current or burden voltage	24 Hours ^[2] 23 °C ± 1 °C	90 Days 23 °C ± 5 °C	1 Year 23 °C ± 5 °C	Temperature coefficient 0 °C to 18 °C 28 °C to 55 °C
Capacitance [7]	1.000 nF	0.001 nF	0.75 µA current source	-	-	2.0 + 0.8	0.02 + 0.001
	10.00 nF	0.01 nF	0.75 µA	-	-	1.0 + 0.5	0.02 + 0.001
	100.00 nF	0.1 nF	8.3µA	-	-	1.0 + 0.5	0.02 + 0.001
	1.000 µF	0.001 µF	83 µA	-	-	1.0 + 0.5	0.02 + 0.001
	10.00 µF	0.01 µF	83 µA	-	-	1.0 + 0.5	0.02 + 0.001
	100.0 µF	0.1 µF	83 µA	-	-	1.0 + 0.5	0.02 + 0.001
	1000 µF	1 µF	0.83 mA	-	-	1.0 + 0.5	0.02 + 0.001
	10000 µF	1 µF	0.83 mA	-	-	2.0 + 0.5	0.02 + 0.001

[1] 20% over range on all ranges, except for 20 mV_{dc}, 1000 V_{dc}, and 3 A_{dc} range.

[2] Relative to calibration standards.

[3] Any current measurement greater than 500 mA will have a temporary thermo-effect. If you wish to measure a lower current or offset current immediately after a high current measurement, ensure that the U3606B has cooled down.

[4] Specifications stated are for 2-wire resistance measurements using the Null math operation. Without Null, add a 0.2 Ω error. To eliminate the noise interference, which might be induced due to the test leads, a shielded test cable is recommended for measuring resistance above 100 kΩ.

5 Characteristics and Specifications

Digital Multimeter Specifications

[5] Specifications stated are for 4-wire low-resistance measurements. The test current is sent from the FORCE terminals and the resistance is measured by the SENSE terminals.

The contact strength may influence the measuring result significantly. Ensure that the connection of the test point is firm to avoid resistance due to contact leads.

The accuracy is specified after source compensation due to environment temperature changes. Initiate the compensation by exiting and entering the Lo- Ω function or by disabling and enabling the output.

The measuring current will be reduced automatically when the product of the test current and resistance exceed 7.5 V. Refer to the test current and resistance as shown below:

Test current	Maximum test resistance	Test current	Maximum test resistance
4 mA	<1200 Ω	8 mA	<938 Ω
5 mA	<1200 Ω	9 mA	<834 Ω
6 mA	<1200 Ω	10 mA	<750 Ω
7 mA	<1072 Ω	-	-

[6] Specifications stated are for the voltage measured at the input terminals only. The test current (1 mA) is typical. Variation in the current source will create some variation in the voltage dropped across a diode junction.

[7] Specifications stated are for open test lead measurements and film capacitor or better using the Null math operation.

NOTE

For the total measurement accuracy, add the probe error. The contact strength will significantly influence to the measuring result. Ensure proper contact at the test point you want to measure.

AC specifications

AC accuracy specifications

Table 5-2 AC accuracy specifications \pm (% of reading + % of range)

Function	Range ^[1]	Frequency range	1 Year 23 °C \pm 5 °C	Temperature coefficient 0 °C to 18 °C 28 °C to 55 °C
True rms AC voltage ^[2]	100.000 mV ^[3]	20 Hz to 45 Hz	1 + 0.1	0.02 + 0.02
		45 Hz to 10 kHz	0.2+ 0.1	0.02 + 0.02
		10 kHz to 30 kHz	1.5 + 0.3	0.02 + 0.02
		30 kHz to 100 kHz ^[4]	5 + 0.3	0.02 + 0.02
	1.00000 V to 750.00 V ^{[5][6]}	20 Hz to 45 Hz ^[7]	1 + 0.1	0.02 + 0.02
		45 Hz to 10 kHz	0.2 + 0.1	0.02 + 0.02
		10 kHz to 30 kHz	1 + 0.1	0.02 + 0.02
		30 kHz to 100 kHz ^{[4][8]}	3 + 0.2	0.02 + 0.02
True rms AC current	10.0000 mA to 3.0000 A ^[9]	20 Hz to 45 Hz	1.5 + 0.1 ^[10]	0.02 + 0.02
		45 Hz to 1 kHz	0.5 + 0.1	0.02 + 0.02
		1 kHz to 10 kHz	2 + 0.2 ^[11]	0.02 + 0.02

[1] 20% over range on all ranges, except for 750 V_{ac} range.

[2] Specifications stated are for input signals greater than 5% of range except for the 100 mV range. No square-wave output are to be used as the signal output.

[3] 100 mV range: specifications stated are for input signals greater than 10% of range.

[4] Additional error 0.003% of full scale per kHz to be added when signal input changes less than 10% of range.

[5] Available ranges: 1.00000 V, 10.0000 V, 100.000 V, 750.00 V

[6] For 750 V range: 847 V is readable

[7] For 750 V range: the accuracy is specified for input less than 200 V_{rms}

5 Characteristics and Specifications

Digital Multimeter Specifications

[8] For 750 V range: the accuracy is specified for input less than 300 V_{rms}

[9] Available ranges: 10.0000 mA, 100.000 mA, 1.00000 A, 3.0000 A

[10] For 3 A range: the accuracy is specified for input less than 3 A

[11] For 1 A and 3 A ranges: the accuracy is specified for frequencies less than 5 kHz.

NOTE

The specification of the AC+DC measurement will be the sum of the AC and DC accuracy. The frequency range will be from 50 Hz for 5½ digit resolution and 225 Hz for 4½ digit resolution.

Frequency specifications

Table 5-3 Frequency accuracy specifications ± (% of reading + % of range)

Function	Range	Frequency range	1 Year 23 °C ± 5 °C	Temperature coefficient 0 °C to 18 °C 28 °C to 55 °C
Frequency ^[1]	Voltage path: 100 mV to 750 V	< 2 Hz	0.18 + 0.003	0.005
		< 20 Hz	0.04 + 0.003	0.005
		20 Hz to 100 kHz	0.02 + 0.003	0.005
		100 kHz to 300 kHz	0.02 + 0.003	0.005
	Current path: 10 mA to 3 A	< 2 Hz	0.18 + 0.003	0.005
		< 20 Hz	0.04 + 0.003	0.005
		20 Hz to 10 kHz	0.02 + 0.003	0.005

[1] For 100 mV and 1 V ranges, the measurable frequency is up to 1 MHz at 0.5 V signal . Minimum input frequency is 1 Hz.

NOTE

All frequency counters are susceptible to errors when measuring low-voltage, low-frequency signals. Shielding inputs from external noise pickup is critical for minimizing measurement errors.

5 Characteristics and Specifications

Digital Multimeter Specifications

Table 5-4 Frequency sensitivity for voltage measurement

Input range ^[1]	Minimum sensitivity (rms sine wave)		
	20 Hz to 100 kHz	100 kHz to 300 kHz	300 kHz to 1 MHz
100 mV	50 mV	50 mV	0.5 V
1.0 V	100 mV	120 mV	0.5 V
10 V	1 V	1.2 V	-
100 V	10 V	12 V	-
750 V	100 V	-	-

[1] Maximum input for specified accuracy = $10 \times$ range or $750 V_{\text{rms}}$ or $1000 V_{\text{dc}}$

Table 5-5 Frequency sensitivity for current measurement

Input range	Minimum sensitivity (rms sine wave)	
	20 Hz to 10 kHz	
10 mA	1 mA	
100 mA	10 mA	
1.000 A	100 mA	
3 A	300 mA	

Duty cycle and pulse width specifications

Table 5-6 Duty cycle and pulse width resolution and accuracy

Function	Range	Resolution	Accuracy of full scale
Duty cycle	100.000% ^[1]	0.001%	0.3% + 0.2% per kHz
	199.999 ms ^[2]	0.001 ms	Duty cycle/Frequency
Pulse width	1999.99 ms ^[2]	0.01 ms	Duty cycle/Frequency

[1] The range is calculated from $\{10 \mu\text{s} \times \text{frequency} \times 100\%$ to $\{[1 - (10 \mu\text{s} \times \text{frequency})] \times 100\%$. For example, a 1 kHz signal can be measured from 1% to 99%.

[2] The positive or negative pulse width must be greater than 10 μs . The range of the pulse width is determined by the frequency of the signal.

Operating specifications

Table 5-7 Reading speed (typical)^[1]

Function	Rate	Reading speed ^[2] (readings/second)	Reading speed over USB ^[3] (readings/second)	Reading speed over GPIB ^[4] (readings/second)
DC voltage (10 V)	Slow (5½ digit)	17	8	8
	Fast (4½ digit)	70	23	22
DC current (1 A)	Slow (5½ digit)	17	8	8
	Fast (4½ digit)	70	26	24
AC voltage (10 V at 1 kHz)	Slow (5½ digit)	17	8	8
	Fast (4½ digit)	70	23	22
AC current (1A at 1 kHz)	Slow (5½ digit)	17	8	8
	Fast (4½ digit)	70	26	24
AC+DC voltage (10 V at 1 kHz)	Slow (5½ digit)	4	2.9	2.9
	Fast (4½ digit)	17	10	10

5 Characteristics and Specifications

Digital Multimeter Specifications

Table 5-7 Reading speed (typical)^[1] (continued)

Function	Rate	Reading speed ^[2] (readings/second)	Reading speed over USB ^[3] (readings/second)	Reading speed over GPIB ^[4] (readings/second)
AC +DC current (1A at 1 kHz)	Slow (5½ digit)	4	2.9	2.9
	Fast (4½ digit)	17	10	10
Resistance (100 kΩ)	Slow (5½ digit)	17	8	8
	Fast (4½ digit)	70	22	22
Lo-Ω (1 kΩ)	Slow (5½ digit)	17	0.8	0.8
	Fast (4½ digit)	70	0.8	0.8
Capacitance (10 μF)	Slow/Fast (3½ digit)	5	1.4	1.4
Diode (1 V)	Slow/Fast (4½ digit)	70	26	23
Frequency (voltage path at 10 V, 1 kHz)	Slow (5½ digit)	9	8	8
	Fast (4½ digit)	9	8	8
Frequency (current path at 1 A, 1 kHz)	Slow (5½ digit)	9	8	8
	Fast (4½ digit)	9	8	8

[1] Based on an average of 500 readings.

[2] Reading rate of the A/D converter.

[3] Number of measurements per second that can be read through USB using SCPI "READ?" command.

[4] Number of measurements per second that can be read through GPIB using SCPI "READ?" command.

Supplemental characteristics

DC voltage	
Measurement method:	Sigma Delta A-to-D converter
Maximum input voltage:	1000 V _{dc} on all ranges
Input impedance:	10 MΩ ± 2% range (typical) in parallel with capacitance < 120 pF
Input protection:	1000 V _{rms} on all ranges
Response time:	Approximately 0.15 s when the displayed reading reaches 99.9% DC value of the tested input signal at the same range
DC current	
Measurement method:	Sigma Delta A-to-D converter
Maximum input current:	10 mA to 3.0 A DC ^[1]
Burden voltage and shunt resistance:	<ul style="list-style-type: none"> • < 0.2 V, 10 Ω for 10 mA range • < 0.2 V, 1 Ω for 100 mA range • < 0.3 V, 0.05 Ω for 1 A range • < 0.7 V, 0.05 Ω for 3 A range
Input protection:	Protected with a 3.15 A/500 V, FF fuse
Response time:	Approximately 0.15 s when the displayed reading reaches 99.9% DC value of the tested input signal at the same range.
AC voltage	
Measurement method:	AC coupled true rms
Maximum input voltage:	750 V _{rms} /1200 V _{peak} /3 × 10 ⁷ V-Hz of product
Input impedance:	1 MΩ ± 2% range (typical) in parallel with capacitance < 120 pF
Input protection:	750 V _{rms} on all ranges

5 Characteristics and Specifications

Digital Multimeter Specifications

Crest factor:	For < 5:1 errors included. Limited by the peak input and 100 kHz bandwidth. Maximum 3.0 at full scale.
Peak input:	300% of range. Limited by maximum input.
Response time:	Approximately 2.5 s when the displayed reading reaches 99.9% AC rms value of the tested input signal at the same range.
Overload ranging:	Will select higher range if peak input overload is detected during auto range. Overload is reported in manual ranging.

AC current

Measurement method:	AC coupled true rms
Maximum input current:	10 mA to 3.0 A DC or AC rms ^[1]
Burden voltage and shunt resistance:	<ul style="list-style-type: none"> • < 0.2 V, 10 Ω for 10 mA range • < 0.2 V, 1 Ω for 100 mA range • < 0.3 V, 0.05 Ω for 1 A range • < 0.7 V, 0.05 Ω for 3 A range
Input protection:	Protected with a 3.15 A/500 V, FF fuse
Crest factor:	For < 5:1 errors included. Limited by the peak input and 100 kHz bandwidth. Maximum 3.0 at full scale.
Peak input:	300% of range. Limited by maximum input.
Response time:	Approximately 2.5 s when the displayed reading reaches 99.9% AC rms value of the tested input signal at the same range.

[1] Any current measurement greater than 500 mA will have a temporary thermo-effect. If you wish to measure a smaller current or offset current measurement immediately after a high current measurement, ensure that the U3606B is cooled down.

Resistance

Measurement method:	Two-wire, open-circuit voltage limited to < 5 V
Open circuit voltage:	< +5.0 V _{dc}
Input protection:	1000 V _{rms} on all ranges, < 0.3 A short circuit

Response time:	Approximately 0.15 seconds for 1 M Ω and ranges below 1 M Ω .
----------------	---

5 Characteristics and Specifications

Digital Multimeter Specifications

Low-resistance	
Measurement method:	Four-wire, the test current is sent from the FORCE terminals and the resistance is measured by the SENSE terminals.
Input protection:	<ul style="list-style-type: none"> • FORCE terminals: Protected with a 3.15 A/250 V FF fuse • SENSE terminals: 1000 V_{rms} on all ranges, < 0.3 A short circuit
Open circuit voltage:	< +8.6 VDC
Continuity	
Measurement method:	0.83 mA ± 0.2% constant current source
Open circuit voltage:	< +5.0 V _{dc}
Audible tone:	Continuous beep when reading is less than threshold resistance of 10 Ω at 1.0 kΩ range
Input protection:	1000 V _{rms} on all ranges, < 0.3 A short circuit
Diode	
Measurement method:	0.83 mA ± 0.2% constant current source
Open circuit voltage:	< +5.0 V _{dc}
Audible tone:	<ul style="list-style-type: none"> • Continuous beep when level is below +50 mV DC • Single tone for normal forward-biased diode or semiconductor junction where 0.3 V ≤ reading ≤ 0.8 V
Input protection:	1000 V _{rms} on all ranges, < 0.3 A short circuit
Capacitance	
Measurement method:	Computed from constant current source charge time, typical 0.2 V to 1.4 V signal level
Maximum voltage at full scale:	<ul style="list-style-type: none"> • For 1 nF to 10 μF range: < 1.5 V • For 100 μF to 10000 μF: < 0.33 V
Input protection:	1000 V _{rms} on all ranges, < 0.3 A short circuit
Response time:	Approximately 1 s for 100 μF and ranges below 100 μF

Charge and discharge voltage: $5 V_{pp}$ (approximately from +3 V to -2 V)

5 Characteristics and Specifications

Digital Multimeter Specifications

Frequency	
Measurement method:	Reciprocal counting technique
Signal level:	10% of range to full scale input on all ranges
Input protection:	<ul style="list-style-type: none"> • Voltage path: 750 V_{rms} on all ranges • Current path: Protected with a 3.15 A/500 V, FF fuse
Maximum display counts (excluding frequency)	
5½ digit:	120,000
4½ digit:	12,000
Measurement noise Rejection	
CMRR (Common Mode Rejection Ratio) for 1 kΩ unbalanced in LO lead:	<ul style="list-style-type: none"> • DC: 140 dB • AC: 70 dB
NMRR (Normal Mode Rejection Ratio):	60 Hz ± 0.1% <ul style="list-style-type: none"> • 5½ digit: 65 dB • 4½ digit: 0 dB 50 Hz ± 0.1% <ul style="list-style-type: none"> • 5½ digit: 55 dB • 4½ digit: 0 dB

DC Power Supply Specifications

Safety considerations

The U3606B is a safety class I instrument, which means it has a protective earth terminal. The terminal must be connected to an earth ground through a power source with a 3-wire ground receptacle.

The DC power supply performance specifications are listed in the following pages. Specifications are warranted in the temperature range of 0 °C to 55 °C with a fix resistive load. Supplemental characteristics – which are not warranted, but are descriptions of performance – are determined either by design or testing.

Specifications assumptions

- Specifications stated are after 60 minutes of warm-up with no load.
- Operating temperature at 18 °C to 28 °C (64.4 °F to 82.4 °F)
- Accuracy is expressed as: $\pm(\% \text{ of output} + \text{offset})$ at 23 °C ± 5 °C
- Temperature coefficient: Add $[0.1 \times (\text{the specified accuracy}) / \text{°C}]$ for 0 °C to 18 °C and 28 °C to 55 °C
- Relative humidity (RH) up to 80% at 30 °C, proportional to 50% for 30 °C to 55 °C

5 Characteristics and Specifications

DC Power Supply Specifications

Performance specifications

Table 5-8 DC power supply performance specifications

Parameter		Specifications				
		S1S2	S1	S1m	S2	S2m
Output ratings		AUTO	30 V/1 A	100 mA /30 V	8 V/3 A	1000 mV /3 A
Programming accuracy 1 year (@ 23 °C ± 5 °C), ±(% of output + offset)	Voltage	0.05% + 5 mV	0.05% + 5 mV	0.05% + 5 mV	0.05% + 5 mV	0.05% + 0.5 mV
	Current	0.15% + 3 mA	0.15% + 3 mA	0.05% + 0.15 mA	0.15% + 3 mA	0.15% + 3 mA
Readback accuracy 1 year over GPIB and USB or front panel with respect to actual output (@ 23 °C ± 5 °C), ±(% of output + offset)	Voltage	0.05% + 5 mV	0.05% + 5 mV	0.05% + 5 mV	0.05% + 5 mV	0.05% + 0.5 mV
	Current	0.15% + 3 mA	0.15% + 3 mA	0.05% + 0.15 mA	0.15% + 3 mA	0.15% + 3 mA
Ripple and noise With outputs ungrounded, or with either output terminal grounded, 20 Hz to 20 MHz	Normal mode voltage	< 2 mV _{rms} ; < 30 mV _{pp}				
	Normal mode current	< 1 mA _{rms}				
Front terminal load regulation ^[1] ±(% of output + offset)	Voltage	< 3 mV + (6 mV/A)	< 3 mV + (6 mV/A)	< 3 mV + (6 mV/A)	< 3 mV + (6 mV/A)	< 0.3 mV + (6 mV/A)
	Current	< 0.03% + 0.3 mA	< 0.03% + 0.3 mA	< 0.03% + 0.03 mA	< 0.03% + 0.3 mA	< 0.03% + 0.3 mA
Rear terminal load regulation ±(% of output + offset)	Voltage	< 0.01% + 3 mV	< 0.01% + 3 mV	< 0.01% + 3 mV	< 0.01% + 3 mV	< 0.01% + 0.3 mV
	Current	< 0.03% + 0.3 mA	< 0.03% + 0.3 mA	< 0.03% + 0.03 mA	< 0.03% + 0.3 mA	< 0.03% + 0.3 mA
Line regulation	Voltage	3 mV typical	3 mV typical	3 mV typical	3 mV typical	0.3 mV typical
	Current	1.5 mA typical	1.5 mA typical	0.15 mA typical	1.5 mA typical	1.5 mA typical

Table 5-8 DC power supply performance specifications (continued)

Parameter	Specifications					
	S1S2	S1	S1m	S2	S2m	
Output ratings	AUTO	30 V/1 A	100 mA /30 V	8 V/3 A	1000 mV /3 A	
Programming resolution	Voltage	1 mV	1 mV	1 mV	1 mV	0.1 mV
	Current	0.1 mA	0.1 mA	0.01 mA	0.1 mA	0.1 mA
Readback resolution	Voltage	1 mV	1 mV	1 mV	1 mV	0.1 mV
	Current	0.1 mA	0.1 mA	0.01 mA	0.1 mA	0.1 mA
Front panel resolution	Voltage	1 mV	1 mV	1 mV	1 mV	0.1 mV
	Current	0.1 mA	0.1 mA	0.01 mA	0.1 mA	0.1 mA
Transient response time	Less than 100 μ s for output to recover to within 15 mV following a change in output current from full load to half load or vice versa.					
Command processing time	Average time for output voltage to begin to change after receipt of digital data when instrument is connected directly to the USB or GPIB is less than 100 ms.					
Over-voltage protection (for CC mode)	Accuracy: 0.5% + 0.5 V Activation time ^[2] : < 2ms					
Over-current protection (for CV mode)	Accuracy: 0.5% + 0.05 A Activation time ^[2] : < 2 ms					

[1] The terminal sense is related to the resistance of the contacts or leads, and proportional to the load condition.

[2] Average time for the detection of OVP or OCP condition. The output will be dropped down and set to standby within 20 ms.

5 Characteristics and Specifications

DC Power Supply Specifications

Supplemental characteristics

Table 5-9 DC power supply supplemental characteristics

Parameter	Characteristics				
	S1	S1m	S2	S2m	
Output ratings	30 V/1 A	100 mA/30 V	8 V/3 A	1000 mV/3 A	
Maximum output programming range	Voltage	CV: 31.500 V		CV: 8.4 V	CV: 1050 mV
		OC: 1.05 A	-	OC: 3.15 A	OC: 3.15 A
		OCP: 1.1 A		OCP: 3.3 A	OCP: 3.3 A
	Current	CC: 1.05 A	CC: 105 mA	CC: 3.15 A	
OV: 31.500 V		OV: 31.500 V	OV: 8.4 V	-	
OCP: 33.000 V		OCP: 33.000 V	OCP: 8.8 V		
Temperature coefficient ± (% of output + offset) maximum change in output /readback per °C for 0 °C to 18 °C/28°C to 55 °C	Voltage	0.005% + 0.5 mV	-	0.005% + 0.5 mV	0.005% + 0.05 mV
	Current	0.02% +1 mA	0.02% +0.01 mA	0.02% +1 mA	-
Remote sensing capability	Voltage drop per load lead	Up to 0.75 V			
	Load regulation	< 0.01% + 3 mV	< 0.01% + 3 mV	< 0.01% + 3 mV	< 0.01% + 0.3 mV
	Maximum load voltage	Subtract voltage drop per load lead			
Voltage programming speed (excludes command processing time)	Full load	Up: 50 ms			
		Down: 50 ms			
	No load	Up: 50 ms			
		Down: 50 ms			

Square-wave output characteristics

Table 5-10 Square-wave output characteristics

Parameter	Range	Characteristics
Amplitude accuracy ± (offset)	S1 (30 V/1 A) & S1S2 (AUTO)	0.2 V
	S2 (8 V/3 A) & S1S2 (AUTO)	0.2 V
Amplitude resolution	S1 (30 V/1 A)	1 mV
	S2 (8 V/3 A)	1 mV
Frequency accuracy ± (% of frequency setting + offset)	(27 steps ^[1])	0.005% + 0.01 Hz
Frequency resolution	-	0.01 Hz
Duty cycle accuracy ± (% of duty cycle setting)	(256 steps : 0.39% to 99.60%)	0.4% ^{[2][3]}
Duty cycle resolution	-	0.39% ^[3]
Pulse width accuracy ^{[3][4]} ± (offset)	(256 steps: 1/frequency)	Duty cycle/frequency
Pulse width resolution	-	Range/256

[1] Available frequencies: 0.5, 2, 5, 6, 10, 15, 25, 30, 40, 50, 60, 75, 80, 100, 120, 150, 200, 240, 300, 400, 480, 600, 800, 1200, 1600, 2400, 4800 (Hz).

If range S1S2 (AUTO) is selected, available frequencies range is 10 to 4800 Hz, with fixed 50% duty cycle.

Output	Range	Adjustable step	Accuracy
Frequency	10.0 Hz to 4800.0 Hz	10 Hz/100 Hz/ 1000 Hz around	0.005% + 0.1 Hz (according to the display of frequency indication)

5 Characteristics and Specifications

DC Power Supply Specifications

[2] For frequency signals greater than 100 Hz, an additional 0.1% per 100 Hz is added. The accuracy of the duty cycle should be calculated as:

$$Accuracy = \left(0.4\% + \left[\left(\frac{frequency}{100} - 1 \right) \times 0.1\% \right] \right)$$

Calculation example: Frequency setting = 4800 Hz, Duty cycle setting = 50%

$$Charateristics\ of\ duty\ cycle = \pm 0.4\% + \left[\left(\frac{4800}{100} - 1 \right) \times 0.1\% \right] = \pm \frac{5.1}{100} = \pm 5.1\%$$

The duty cycle accuracy (for frequency setting 4800 Hz) is calculated as 50% \pm 5.1%.

[3] Characteristic applies when the positive or negative pulse width is greater than 50 μ s.

[4] For frequency signals greater than 100 Hz, an additional 0.1% per 100 Hz is added. The accuracy of the pulse width should be calculated as:

$$Accuracy = \frac{\left(0.4\% + \left[\left(\frac{frequency}{100} - 1 \right) \times 0.1\% \right] \right)}{frequency}$$

Calculation example: Frequency setting = 4800 Hz, Duty cycle setting = 50%

$$Characteristics\ of\ pulse\ width = \pm \left(\left(0.4\% + \left[\left(\frac{4800}{100} - 1 \right) \times 0.1\% \right] \right) \times \frac{1}{4800} \right) = \pm \left(\frac{5.1}{100} \times \frac{1}{4800} \right) = \pm 10.625\ \mu s$$

The pulse width accuracy (for frequency setting 4800 Hz and duty cycle setting 50%) is calculated as 0.1042 ms \pm 10.625 μ s.

NOTE

- The rise and fall time are 25 μ s typically between 10% and 90% of the signal amplitude.
- The additional load regulation is 0.15 V/A.

Sweep characteristics

Table 5-11 Scan output characteristics

Scan	Constant voltage			Constant current		
	S1	S2	S2m	S1	S1m	S2
Range	S1	S2	S2m	S1	S1m	S2
Maximum amplitude ^[1]	31.500 V	8.400 V	1050.0 mV	1.0500 A	105.00 mA	3.1500 A
Step	1 step to 100 steps			1 step to 100 steps		
Dwelling time	1 s to 99 s			1 s to 99 s		

[1] Amplitude start position is fixed at 0 (V or A) by default.

Table 5-12 Ramp output characteristics

Ramp	Constant voltage			Constant current		
	S1	S2	S2m	S1	S1m	S2
Range	S1	S2	S2m	S1	S1m	S2
Maximum amplitude ^[1]	31.500 V	8.400 V	1050.0 mV	1.0500 A	105.00 mA	3.1500 A
Step	1 step to 10000 steps			1 step to 10000 steps		
Dwelling time	100 ms (typical) per step			100 ms (typical) per step		

[1] Amplitude start position is fixed at 0 (V or A) by default.

5 Characteristics and Specifications
DC Power Supply Specifications

THIS PAGE HAS BEEN INTENTIONALLY LEFT BLANK.

6

List of Error Messages

Error Messages	182
Command errors	183
Execution errors	184
Internal errors	185
Query errors	185
Device specific errors	185
Self-test errors	186
Calibration errors	187

The U3606B error messages are summarized in this chapter.

Error Messages

Error messages are created once an erroneous condition is detected.

Errors are retrieved in first-in-first-out (FIFO) order using the `SYSTem:ERRor?` query or read from the front panel (see [page 129](#)).

The first error returned is the first error that was stored. Reading this error will clear this error allowing the next stored error to be read (if there are other errors stored). Once you have read all of the interface-specific errors, the errors in the global error queue will be retrieved.

If more than 20 errors have occurred, the last error stored in the queue (the most recent error) is replaced with error number: `-350, "Queue overflow"`. No additional errors are stored until you remove the previously stored errors from the queue.

If no errors have occurred when you read the error queue, the instrument responds with the message: `+0, "No error"` or `"nonE"` if read from the front panel.

The interface-specific and global error queues are cleared by the clear status (`*CLS`) command and when the instrument power is cycled. The error queue will not be cleared by a Factory Reset (`*RST` command) or an Instrument Preset (`SYSTem:PRESet` command).

Command errors

The following table shows the list of command errors. These errors set the Standard Event Status register bit 5.

Table 6-1 List of command errors

Error code	Error message
+0	No error
-100	Command error
-101	Invalid character
-102	Syntax error
-103	Invalid separator
-104	Data type error
-108	Parameter not allowed
-109	Missing parameter
-112	Program mnemonic too long
-113	Undefined header
-120	Numeric data error
-121	Invalid character in number
-123	Exponent too large
-128	Numeric data not allowed
-130	Suffix error
-131	Invalid suffix
-134	Suffix too long
-138	Suffix not allowed
-141	Invalid character data
-144	Character data too long
-148	Character data not allowed

6 List of Error Messages

Error Messages

Table 6-1 List of command errors (continued)

Error code	Error message
-150	String data error
-151	Invalid string data
-158	String data not allowed

Execution errors

The following table shows the list of execution errors. These errors set the Standard Event Status register bit 4.

Table 6-2 List of execution errors

Error code	Error message
-200	Execution error
-211	Trigger ignored
-213	Init ignored
-214	Trigger deadlock
-220	Parameter error
-221	Settings conflict
-222	Data out of range
-223	Too much data
-230	Data corrupt or stale

Internal errors

The following table shows the list of internal errors.

Table 6-3 List of internal errors

Error code	Error message
-350	Queue overflow

Query errors

The following table shows the list of query errors. These errors set the Standard Event Status register bit 2.

Table 6-4 List of query errors

Error code	Error message
-410	Queue INTERRUPTED
-420	Query UNTERMINATED

Device specific errors

The following table shows the list of device specific errors. These errors set the Standard Event Status register bit 3.

Table 6-5 List of device specific errors

Error code	Error message
510	Voltage output over protection
511	Current output over protection
512	Voltage output over limit setting

6 List of Error Messages

Error Messages

Table 6-5 List of device specific errors (continued)

Error code	Error message
513	Current output over limit setting
521	Input buffer overflow
532	Cannot achieve requested resolution
540	Cannot use overload as math reference

Self-test errors

The following errors indicate failures that may occur during a self-test.

Table 6-6 List of self-test errors

Error code	Error message
630	EEPROM read failure
631	Program ROM Checksum failed
632	Program RAM failed
633	Display board failed
634	ADC failed
635	Interface board failed
636	Source board failed
637	I/O Processor Failed Self-Test
638	Source Processor Failed Self-Test
639	DC Path error
640	AC Path attenuated error
641	AC Path attenuated 10 error
642	AC Path attenuated 100 or amplified 10 error

Table 6-6 List of self-test errors (continued)

Error code	Error message
643	Frequency measurement path failed
644	Constant Current 0.2V/1kohm error
645	Constant Current 0.2V/10kohm or amplified 11 error
646	Constant Current 0.8V/100kohm or amplified 11 error
647	Constant Current 0.8V/1.1Mohm or amplified 11 error

Calibration errors

The following errors indicate failures that may occur during a calibration.

Table 6-7 List of calibration errors

Error code	Error message
701	Cal security pads short
702	Cal secured
703	Invalid secure code
704	Secure code too long
705	Cal aborted
706	Cal value out of range
707	Cal signal measurement out of range
708	Cal signal frequency out of range
709	Cal source unfinished
710	EEPROM write failure
720	Cal DCV offset out of range
721	Cal DCI offset out of range
722	Cal RES offset out of range

6 List of Error Messages

Error Messages

Table 6-7 List of calibration errors (continued)

Error code	Error message
723	Cal CAP offset out of range
726	Cal RES open out of range
742	Cal checksum failed, DCV corrections
743	Cal checksum failed, DCI corrections
744	Cal checksum failed, RES corrections
745	Cal checksum failed, ACV corrections
746	Cal checksum failed, ACI corrections
747	Cal checksum failed, FREQ correction
748	Cal checksum failed, CAP corrections
750	Source board failed on reading
751	Source board failed on sense

www.keysight.com

Contact us

To obtain service, warranty, or technical assistance, contact us at the following phone or fax numbers:

United States:

(tel) 800 829 4444 (fax) 800 829 4433

Canada:

(tel) 877 894 4414 (fax) 800 746 4866

China:

(tel) 800 810 0189 (fax) 800 820 2816

Europe:

(tel) 31 20 547 2111

Japan:

(tel) (81) 426 56 7832 (fax) (81) 426 56
7840

Korea:

(tel) (080) 769 0800 (fax) (080) 769 0900

Latin America:

(tel) (305) 269 7500

Taiwan:

(tel) 0800 047 866 (fax) 0800 286 331

Other Asia Pacific Countries:

(tel) (65) 6375 8100 (fax) (65) 6755 0042

Or visit Keysight World Wide Web at:

www.keysight.com/find/assist

Product specifications and descriptions in this document are subject to change without notice. Always refer to the Keysight website for the latest revision.

This information is subject to change without notice.
© Keysight Technologies 2013, 2014
Edition 2, August 2014



U3606-90054
www.keysight.com